

# Manual

## For Operation



## UCS 500Mx

The ultra-compact simulator  
and its system modules

**UCS 500** upgrade version

**UCS 500 M4**

**UCS 500 M6**

**UCS 500 M6A**

UCS500Mx - designed as a modular system - is the most intelligent solution offering exactly what you need for full-compliant immunity tests against transient and power fail phenomena. The distinct operation features, convenient DUT connection facilities, a clearly arranged menu structure and display philosophy as well as the pre-programmed standard test routines make testing easy, reliable and safe. Extendable by a variety of test accessories the UCS500Mx is a universal equipment for a broad range of recommendations even for three-phase applications up to 100A

EN/IEC 61000-4-2  
EN/IEC 61000-4-4  
EN/IEC 61000-4-5  
EN/IEC 61000-4-8  
EN/IEC 61000-4-9  
EN/IEC 61000-4-11  
EN/IEC 61000-4-12  
EN/IEC 61000-4-29  
EN 61000-6-1  
EN 61000-6-2

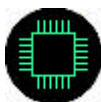

## Contens

<b>1.</b>	<b>Model Overview .....</b>	<b>4</b>
1.1.	UCS Models .....	4
<b>2.</b>	<b>Standards covered by UCS 500 M4 / M6 / M6A .....</b>	<b>4</b>
<b>3.</b>	<b>Operating Functions.....</b>	<b>5</b>
3.1.	Front view.....	5
3.2.	Rear view .....	6
<b>4.</b>	<b>Operation.....</b>	<b>9</b>
4.1.	Description of the menus .....	9
4.2.	Menu structure .....	9
4.3.	Main Menu.....	10
4.4.	Service .....	11
4.5.	Setup.....	12
<b>5.</b>	<b>Test Equipment UCS 500 M .....</b>	<b>13</b>
<b>6.</b>	<b>Technical data.....</b>	<b>14</b>
6.1.	EFT Electrical Fast Transients Burst as per IEC 61000-4-4.....	14
6.2.	SURGE Immunity requirements as per IEC 61000-4-5.....	15
6.3.	Power Fail Generator as per IEC 61000-4-11 .....	16
6.4.	ESD as per EN 61000-4-2, EN 61000-6-1/2, IEC 61000-4-2, IEC 801-2.....	17
6.5.	General Specifications .....	17
6.6.	UCS 500 upgrade version.....	18
<b>7.</b>	<b>Maintenance and service .....</b>	<b>19</b>
7.1.	General.....	19
7.2.	Test set- up .....	19
7.3.	Calibration and verification.....	19
<b>8.</b>	<b>Delivery Groups.....</b>	<b>20</b>
8.1.	Basic equipment.....	20
8.2.	Accessories and options .....	20
<b>9.</b>	<b>EFT Burst as per IEC 61000-4-4.....</b>	<b>21</b>
9.1.	Operation.....	21
9.1.1.	Quick Start .....	21
9.1.2.	Standard test routines .....	22
9.1.3.	User Test Routines .....	23
9.2.	Burst generation.....	25
9.3.	Test level with Burst as per IEC 61000-4-4 Ed.2.....	25
9.4.	Coupling decoupling network.....	26
9.4.1.	Coupling/decoupling network for ac/dc power lines.....	26
9.4.2.	Capacitive coupling clamp .....	27
9.5.	Burst Test Setup .....	27
<b>10.</b>	<b>Surge Immunity as per IEC 61000-4-5.....</b>	<b>28</b>
10.1.	Operation.....	28
10.1.1.	Quick Start .....	29
10.1.2.	Standard test Routine .....	30
10.1.3.	User Test Routines .....	32
10.1.4.	Pulsed magnetic field as per IEC 61000-4-9 .....	33
10.1.5.	Ring Wave.....	34
10.1.6.	Setup current limiter for surge current .....	34
10.2.	Surge pulse generation .....	35
10.3.	Coupling decoupling network.....	35
10.3.1.	Coupling to ac/dc power supply lines.....	35
10.3.2.	Coupling to I / O lines.....	35
10.4.	Test set-up .....	35

<b>11. Voltage Dips as per IEC 61000-4-11 .....</b>	<b>36</b>
11.1. Operation.....	36
11.1.1. Quick Start .....	37
11.1.2. Standard Test Routines .....	38
11.1.3. User test routines .....	41
11.2. The Power Fail Test.....	42
11.3. The Power Fail Test.....	43
11.3.1. Voltage Interruptions .....	43
11.3.2. Voltage dips, voltage variations .....	44
11.4. DC Power networks .....	44
11.5. Test setup and accessories .....	45
11.5.1. Transformer type V4780 .....	45
11.5.2. Motor variac type MV 2616 .....	47
11.6. 50/60Hz Magnetic Field as per IEC 61000-4-8.....	49
<b>12. Electrostatic Discharge as per IEC 61000-4-2 .....</b>	<b>50</b>
12.1. Operation.....	50
12.2. Quick Start .....	51
12.3. Standard test routines .....	51
12.4. ESD Generator.....	52
12.4.1. Test set-up according IEC 61000-4-2 .....	52
12.4.2. Test application .....	53
12.4.3. Test Level IEC 61000 - 4 - 2 .....	53
12.4.4. Discharge Unit.....	54
<b>13. Appendix .....</b>	<b>55</b>
13.1. Declaration of CE-Conformity .....	55
13.2. UCS 500 M - General Diagram .....	56
13.3. Main diagram control connection .....	56
13.4. Main diagram high voltage connection .....	57

## 1. Model Overview

### 1.1. UCS Models

#### Standard models

Model	Pulse voltage	CDN		
UCS 500	4kV	250V	16A einphasig	upgrade version
UCS 500 M4	4kV	250V	16A single phase	
UCS 500 M6	6kV	250V	16A single phase	
UCS 500 M6A	6kV	250V	16A single phase	

#### Special models

Special models have the index UCS500Mx Sx. The difference to the standard models are the voltage and current ranges. The operation is the same as by the standard UCS equipment's.

Model	Pulse voltage	CDN	
UCS 500 M4 S1	4kV	250V	32A single phase

## 2. Standards covered by UCS 500 M4 / M6 / M6A

A fully equipped UCS 500M covers the following standards

- IEC 61000-4-2            **ESD**
- IEC 61000-4-4            **Burst**
- IEC 61000-4-5            **Surge**
- IEC 61000-4-8            **50/60Hz magnetic field**
- IEC 61000-4-9            **Pulse magnetic field**
- IEC 61000-4-11          **Voltage dips**  
**Voltage interruptions**  
**Voltage variations for ac power mains supply**
- IEC 61000-4-12          **Ringwave**
- IEC 61000-4-29          **Voltage interruptions**  
**Voltage dips for dc power supply systems**
- ANSI                        **Surge with 2W couplings ( M6A only )**

### 3. Operating Functions

#### 3.1. Front view

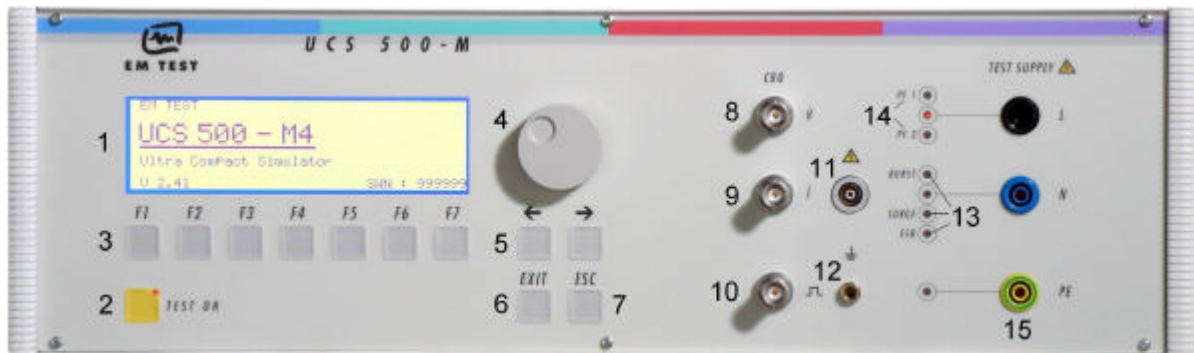

1	Display	6	Exit	11	HV pulse Burst output 50 $\Omega$
2	"Test On"	7	Escape	12	Ground reference
3	Function keys "F1..F7"	8	CRO U (surge)	13	Coupling (burst, surge and ESD)
4	Knob (Inc / Dec)	9	CRO I (surge)	14	Channel PF1 and PF2
5	Cursor keys "←" and "→"	10	CRO trigger output $\uparrow$ 5V	15	EUT test supply

#### 1 Display

All functions and parameters are displayed (8 lines with max. 40 characters).

#### 2 Test On

By pressing the key "Test On" the test procedure is initiated with the preselected parameters. The red LED indicates the trigger of a burst event.

#### 3 Function keys "F1 .. F7"

Parameters and functions, displayed in the lowest line, can be selected with the related function key.

#### 4 Knob (Inc / Dec)

The knob increments or decrements test parameters with a numeric value or selects from a list of parameters.

#### 5 Cursor keys

Parameters and functions can be changed on-line. The selection of these parameters is realized with the cursor moving to the left or to the right.

#### 6 Exit

Pressing of the Exit function will cause a reset of the firmware. This is only possible if no test routine is running.

#### 7 ESC

When pressing the ESC button the user moves back one page in the menu.

#### 8 CRO U (surge)

At the BNC output the voltage pulse (surge) of the generator can be measured. The max. level is 10V

#### 9 CRO I (surge)

At the BNC output the current pulse (surge) of the generator can be measured. The max. level is 10V

#### 10 BNC - CRO Trigger

At the BNC output the generator trigger can be checked, e.g. the burst duration, the burst repetition rate and the spike frequency (+15 V rectangular). This output can be generally used as oscilloscope trigger output and is synchronous to the following events

- Burst and surge release
- Voltage dip or interruption, start of the event
- ESD contact discharge

#### 11 HV pulse output 50

External coupling devices such as the capacitive coupling clamp and the 3-phase coupling network are connected to the coaxial 50 ohm output. Also the calibration of the generator is handled at this output

#### 12 Ground reference

During test or calibration procedure the burst generator must be grounded to the reference ground plane

#### 13 Coupling mode

The actual coupling mode is indicated by LED

#### 14 Channel PF1/PF2

This LED indicates the channel mode during the power fail test.

#### 15 EUT test supply

For single-phase EUT the coupling/decoupling network is part of the generator. The EUT is powered via the safety banana plugs at the front panel of the simulator

### 3.2. Rear view



- |  |                                 |
|--|---------------------------------|
| 1 Test supply input; channel PF1 together with the red lamp for phase indication | 4 Test supply input PE          |
| 2 Test supply input; channel PF2 together with the red lamp for phase indication | 5 Sync input                    |
| 3 Test supply input neutral  | 6 Reference earth connection    |
|  | 7 HV output for Surge pulse     |
|  | 8 Common output for Surge pulse |

#### 1 Test supply PF1

The phase of the power supply for the EUT is connected to the banana connector PF1. The phase L is conducted to the EUT voltage supply via PF1 if channel PF1 is selected in the set-up menu.

To guarantee a correct function of the synchronization the phase shall be connected to this input. The red lamp than shall be alighted

#### 2 Test supply PF2

The phase of the power supply for the EUT is connected to the banana connector PF2. This input is generally used for voltage dip testing as per IEC 61000-4-11. At this input the reduced dip voltage is applied. The phase L is conducted to the EUT voltage supply via PF2 if channel PF2 is selected in the set-up menu. Normally a variac is connected to PF2, e.g., 0-250V. A motor driven variac can be controlled via a 0-10V analogue control output. To guarantee a correct function of the synchronization the phase shall be connected to this input. The red lamp than shall be alighted

#### 3 Test supply neutral ( PF1/PF2 )

The neutral line of the power supply for the EUT is connected to the banana connector N

#### 4 Test supply PE ( PF1/PF2 )

The protective earth line of the power supply for the EUT is connected to the banana connector PE

#### 5 SYNC input

An ac voltage to which the events shall be synchronized is connected to this input. If no voltage is available the tests are started automatically in asynchronous mode. Normally this input shall be connected directly to L of the channel PF1. The maximum input voltage is 250Vac

#### 6 Reference earth connection

The generator has to be connected to the reference earth plane of the test set up. The connection at the rear part of the generator is an alternative to the grounding point at the front panel

#### Connection EUT supply

The EUT power supply is normally connected to the UCS plugs PF1, N and PE

A tap of a motor variac or adapting transformer for power fail testing is connected to the connection PF2.

The phase synchronisation SYNC must be connected to PF1. By missing this connection all tests runs in asynchronous mode with no phase angle adjust for pulse release.

The earth bolt must be connected to the ground reference.

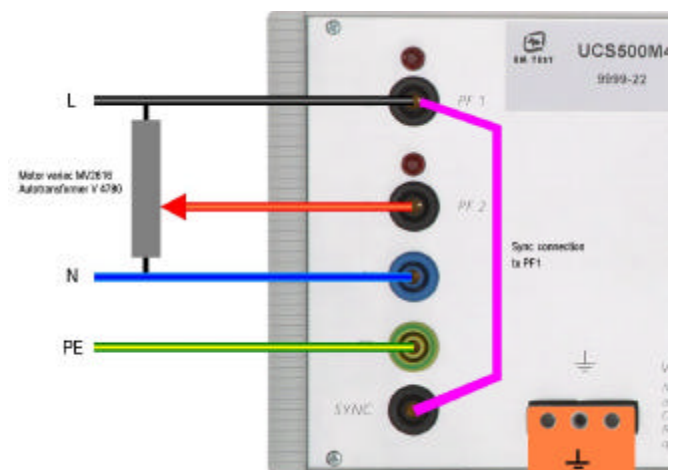



- 7 HV output for Surge pulse
- 8 Common output for Surge pulse
- 9 Ventilation
- 10 Warning lamp
- 11 External trigger
- 12 BNC connector MON U
- 13 BNC connector MON I

### 7 HV output

The coax plug is the HV HIGH output of the simulator. It is used for external coupling/decoupling networks as well as for the RWG 500 modules

### 8 COM output

The Com output is the HV LOW output of the simulator. The output is floating



#### Attention

The direct output of the surge generator is located at the rear panel of the instrument, HV and COM. It is not allowed to connect these outputs to any other coupling/decoupling network than manufactured by EM TEST, e.g. the types CNV and CNI. Before to connect any external networks to this output the operator must contact the manufacturer. Any damages due to this matter are not covered by warranty.

The direct pulse output shall also not be used to connect the generator directly to any power conducting lines

The waveshape measured at the direct pulse output must not be within the tolerances specified in IEC 61000-4-5. The pulse shape shall be verified at the CDN output directly, no matter whether it is an internal or external CDN.

### 9 Ventilation

After long term duration tests the generator should keep on running for some minutes to cool down the system.

### 10 Warning lamp

A voltage free contact is available for external warning indications (warning lamp). The signal is generated after pressing TEST ON.

### 11 External trigger

One single event, burst, surge, voltage dip or ESD can be released. Trigger level 5-15V positive going.

### 12 BNC connector MON U

At this BNC connector the output power supply voltage for the EUT can be measured. The max. level is 10V.

### 13 BNC connector MON I

At this BNC connector the output current for the EUT can be measured, e.g. the nominal current or the peak inrush current. The rating is 10mV/A.



- |  |                             |
|--|-----------------------------|
| 14 Control voltage 0-10V                 | 19 Serial interface RS 232  |
| 15 Security circuit                      | 20 Parallel interface IEEE  |
| 16 Mains selector 115V / 230V            | 21 Remote control connector |
| 17 Power on switch                       | 22 FAIL 1                   |
| 18 Fuse of the high voltage power supply | 23 FAIL 2                   |

#### 14 Mains selector

The voltage is used to control external power sources. The source is normally connected to the channel PF2 (normally a motor driven variac). The voltage level is selectable via the operating facilities of the UCS 500M. The voltage level can also be selected within the service menu under the function „setup.

#### 15 Safety circuit

The test can only be started if the security circuit is closed. If the circuit is opened during a running test the simulator will be switched off immediately.

#### 14 Mains selector

Selection of 115V / 230V

#### 17 Power on switch

The switch is part of the mains filter. Mains fuses are part of the filter. (230V / 1A and 115V / 2A )

#### 18 Fuse of the high voltage power supply

The high voltage power supply is protected by this fuse „F3“. In case that no high voltage is generated but the control unit works properly this fuse shall be checked.

#### 19 Serial interface

RS 232 interface with a 9-pole connector.

#### 20 Parallel interface GPIB / IEEE 488

IEEE 488 interface with IEEE connector

#### 21 Remote control connector CN

External coupling devices are controlled via this remote control connector.

#### 22 Fail detection FAIL 1 EUT control (TEST STOP)

Grounding this input will cause a complete stop of the running test procedure. (+15V to ground) The test must be completely restarted.

#### 23 Fail detection FAIL 2 EUT control (TEST PAUSE)

Grounding this input will cause a break for the running test procedure (+15V to ground). The test will be continued when the input is no more connected to ground.



## 4. Operation

### 4.1. Description of the menus

The simulator is operated by an easy menu control system. Seven function keys are available to select parameters and functions.

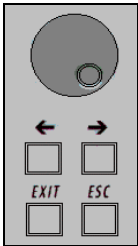

The selected parameter is blinking and can be changed by turning the knob (incr./decr.). The digit to be changed can be selected with the cursor (←→).

ESC will take you back to the previous level in the menu and set the displayed values. The latest settings are stored automatically and will be recalled when the menu is selected again.

EXIT will reset the firmware to the main screen.

All functions are indicated on the display; max. 8 lines and 40 characters.

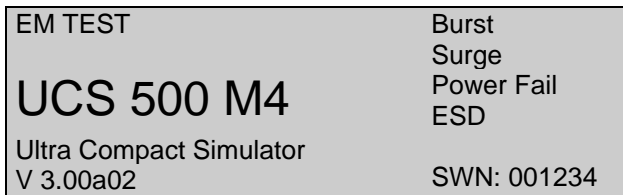

The serial number and the version number SWN are used for traceability reasons. These numbers are listed in the test reports and calibration certificates. These numbers also are listed within the test reports generated by the ISM ISO software.

Start-up display example UCS 500M4. The models type is displayed after startup.

### 4.2. Menu structure

Level 0...4

Level 0	Level 1	Level 2	Level 3	Level 4
<b>MAIN MENU</b> F1 BURST IEC 61000-4-4 F2 SURGE IEC 61000-4-5/9 F3 PFS IEC 61000-4-11/8/29 F4 ESD IEC 61000-4-2 F7 SERVICE	<b>Burst</b> IEC 61000-4-4 F1 Quick Start F2 Standard routines F3 User test routines	<b>Quick Start</b> F1 Start F2 Change F3 Continue	<b>Start</b> Start the test routine <b>Change</b> Select all parameters <b>Continue</b> Continue the test routine	
	<b>Surge</b> IEC 61000-4-5/9	<b>Standard routines</b> Preprogrammed test routines as per standard requirements	<b>Standard routines</b> F1 : F4 IEC 61000-4-4 Level 1-4 F5 Generic Standard EN 61000-6-1 F6 Generic standard EN 61000-6-2 F7 Manual standard routine	<b>Standard routines F1..F3</b> F1 Start F2 Change F3 Continue
	<b>Power Fail</b> IEC 61000-4-8/11/29	<b>User test routines</b> Preprogrammed test routines for evaluation and design support	F1 Synchronous to the mains F2 Random burst release F3 Change V after T by ΔU F4 Frequency sweep I F5 Frequency sweep II F6 Frequency sweep III F7 Change polarity after T	<b>User test routines F1..F3</b> F1 Start F2 Change F3 Continue
	<b>ESD</b> IEC 61000-4-2	<b>Setup</b> F1 Change language F2 LCD backlighting F3 Interfaces F4 ESD/keyboard beeper F5 Running time clock F6 Set voltage F7 Magnetic field factors	<b>Change language</b> Gern or English <b>LCD backlighting</b> On, Off or Auto <b>Interfaces</b> Select all parameters <b>ESD/keyboard beeper</b> (on, off) <b>Running time clock</b> Display of the TEST ON time <b>Set voltage</b> (ext. motor variac) <b>Magnetic field factors</b> Correction factors for magnetic field antenna and current transformer	
	<b>Service</b> F1 Adresses F3 Setup F4 Change standard levels	<b>Change standard level</b>	<b>Change standard level</b> F1 All parameters to standard level F2 IEC 61000-4 F3 EN 61000-6-1 F4 EN 61000-6-2	<b>Change standard levels</b> F1 IEC 61000-4-4 Burst F2 IEC 61000-4-5 Surge ...

### 4.3. Main Menu

MAIN MENU	
F1 : BURST	IEC 61000-4-4
F2 : SURGE	IEC 61000-4-5/9/12
F3 : POWER FAIL	IEC 61000-4-11/8/29
F4 : ESD	IEC 61000-4-2
F7 : Service	
F1	F2
F3	F4
F5	F6
F7	

#### F1 Burst test

With function key F1 the user can select Burst Test as per **IEC 61000-4-4** . The test pulses are fast transients with a pulse shape of 5/50ns.

**Attention:** The generator covers complete the new specifications given in the draft revision IEC 61000-4-4 edition 2 ( 2004). This means a new spike frequency which is selectable between 5kHz and 100kHz. The burst duration is automatically matched between 15ms and 0.75ms. The common mode coupling is new with all copplings at the same time.

#### F2 Surge test

With function key F2 the user can select Surge Test as per **IEC 61000-4-5** . The test pulses are high energy pulses with a voltage shape of 1,2/50 $\mu$ s and a short circuit current shape of 8/20 $\mu$ s.

The **M6A** type additionally supports coupling modes to meet the **ANSI** standard.

In addition the test procedure for Pulse Magnetic Field testing as per **IEC 61000-4-9** and the Ring Wave Test as per **IEC 61000-4-12** or **ANSI/IEEE** is included in this menu.

To select the RWG option the user has to enable this menu within the service menu, under "Setup" and than "Set Voltage".

#### F3 Power Fail test

With function key F3 the user can select the Power Fail Test as per **IEC 61000-4-11**.

The simulator will generate voltage dips and voltage fluctuations with preselectable parameters. **IEC 61000-4-11** is valid for ac power supply systems. For dc supply system in future **IEC 61000-4-29** shall be recommended. In addition the test procedure for 50/60Hz Magnetic Field Testing as per IEC 61000-4-8 is included within the menu.

The Power fail menu includes a **Voltage Variation** test as per IEC 61000-4-11 as test procedure. The simulator will generate voltage variations in the second range.

**Attention:** The generator covers already the new specifications given in FDIS IEC 61000-4-11 ( 2004). This means the introduction of a new 80% test level as well as a new function for the Voltage Variation test.

#### F4 ESD as per IEC 61000-4-2

With function key F4 the user selects the ESD mode. In addition the ESD discharge gun shall be connected to the rear output of the UCS.

#### F7 Service

Setup and servicing routines are available.

#### 4.4. Service

SERVICE						
F1 : Addresses						
F3 : Set-up						
F4 : Change standard levels						
F7 : Status						
F1	F2	F3	F4	F5	F6	F7

##### F1 Addresses

The addresses of the EM TEST AG and the EM TEST GmbH are shown. For all other addresses of all EM TEST sales partners refer to the URL [www.emtest.com](http://www.emtest.com).

##### F3 Set-up

The software will clearly explain the set-up procedure.

##### F4 Change standard levels

F1: Set all parameters acc to standard The stored standard test levels can be changed within this menu. The settings are actualised to the standards dated in summer 2004.

##### F2: IEC 61000-4

F1: IEC 61000-4-4	Burst
F2: IEC 61000-4-5	Surge
F3: IEC 61000-4-8	Magnetic field AC
F4: IEC 61000-4-9	Magnetic field Surge
F5: IEC 61000-4-11	Power Fail AC
F6: IEC 61000-4-29	Power Fail DC
F7: IEC 61000-4-2	ESD

##### F3: EN 61000-6-1 Generic

F1: EN 61000-6-1	Generic Burst
F2: EN 61000-6-1	Generic Surge
F3: EN 61000-6-1	Generic Power Fail

##### F4: EN 61000-6-2 Generic

F1: EN 61000-6-1	Generic Burst
F2: EN 61000-6-1	Generic Surge
F3: EN 61000-6-1	Generic Power Fail

##### F7 Status

Status information of the equipment.

##### Page 1

<b>UCS Model</b>	<b>Built in modules</b>	
Firmware Version		
Firmware Number		
<b>Option</b> Burst		
<b>Operating time</b>	<b>DI – Status</b>	00000
Device powered on	<b>SCR-Status</b>	00000
<b>Testing time</b>		
Device test time	2/2	

##### Page 2

<b>Status</b> Keyboard - Beep	<b>RS 232</b>	Baudrate
<b>Status</b> ESD - Beep	<b>IEEE</b>	Address
<b>Status</b> Backlighting		
<b>Voltage</b>	<b>Magnetic field values</b>	
V : max ext. Variac	Cf :Coil factor	
Vn : Nominal voltage	Tf : Transformer factor	
Ch : Default channel	If : Impedance factor	

## 4.5. Setup

SETUP						
F1 : Change language / Sprache ändern						
F2 : LCD backlighting						
F3 : Interfaces						
F4 : Beep						
F5 : Timer						
F6 : Set voltage						
F7 : Magnetic field correction factors						
F1	F2	F3	F4	F5	F6	F7

### F1 Change language

The user can chose between two languages, German and English.

### F2 LCD backlighting

With the use of F2 the backlighting can be switched on or off.

Additionally the **Auto Off** function can be programmed to switch off the backlighting after a defined time that the equipment has not been in operation (1 - 30min). Because of the limited lifetime of LCD displays, approx. 10,000h this function should always be activated.

### F3 Interfaces

This menu will help the user to define the status of the integrated serial and parallel interfaces, e.g. the baud rate of the RS 232 or the address of the IEEE interface.

### F4 Beep

F1 is the selector for the keyboard beeper ON/OFF mode. (Short beep at every keyboard hit)

F3 is the selector for the ESD-beeper ON/OFF mode. (Short beep at releasing an ESD pulse)

To indicate that a running test is finished the beeper sounds allways 3 times (not changeable).

### F5 Operating time

Pressing of F5 will show the different operating time and status of the test equipment.

Operating time : Total time where the UCS is powered on.

Testing Time : Total time during a running test.

DI – Status : Service information about internal digital inputs.

SCR – Status : Service information about surge switch operation

### F6 Set voltage

For control of an external power supply source an analogue control voltage can be programmed (0-10V dc).

The operator can specify the following parameters:

F1: **Max. variac voltage** V [ V ] Maximal output voltage at 100% position of the external motor variac or dc controlled voltage source. The analogue reference value for the max. voltage is 10V.

F2: **Mains supply voltage** V [ V ] of the device under test. This voltage shall be specified by the operator and depends on the type of equipment under test. The variac normally is automatically set to this output voltage.

F3: **Default channel**. The operator select the default channel PF1 or PF2 from which the EUT is powered.

F4: **Ring Wave**. For RWG testing the operator can select between two different modules:

- No module ( the RWG operation within the Surge menu is not available ).
- M4 module up to max 4000V
- M6 module up to max 6000V

### F7 Magnetic field correction factors

F1 : Coil factor      Af [A/m]      Range [ 0.20...9.99      step 0.01 ]

F2 : Transformer factor      Tf [A/V]      Range [ 0.020...9.999      step 0.001 ]

F3 : Impedance factor      If [A/V]      Range [ 0.20...1.00      step 0.01 ]

These values are delivered together with the necessary options to conducted magnetic field testing.

- Coil factor depends on the type of antenna which is used for the test.
- Transformer factor depends on the type of transformer which is used for the test.
- Impedance factor depends on the type of surge generator which is used for the test. A generator with a source impedance of  $2\Omega$  needs an impedance factor of approx.  $I_f = 0.5$

## 5. Test Equipment UCS 500 M

The simulator UCS 500M is separated in different main parts. Each functional part is sep separately-held mounted. The control unit is screened to all other parts.

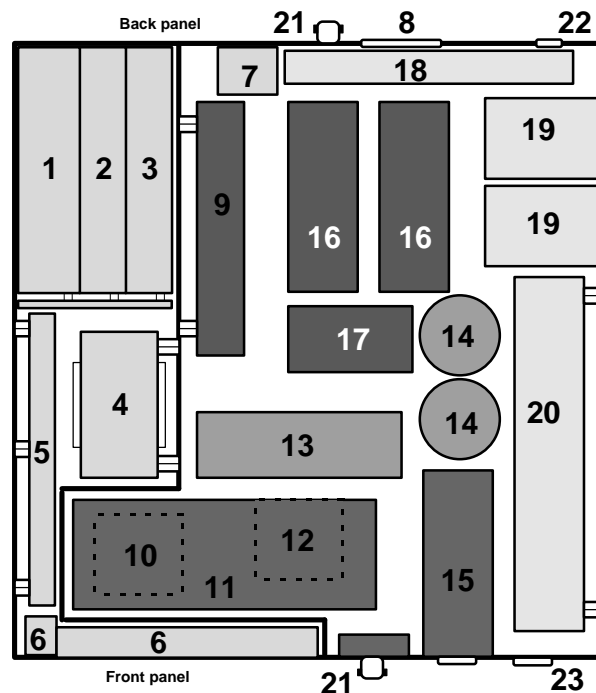

### Control unit

- 1 Power supply board
- 2 Interface board
- 3 Controller board
- 4 Power supply transformer

### High voltage unit

- 9 High voltage power supply
- 10 Storage capacitor
- 11 HV- board
- 12 ESD controller board
- 13 Surge switch-board

### Coupling/decoupling unit

- 18 Filter board
- 19 Decoupling chokes
- 20 Coupling/decoupling network

- 5 Filter board / connecting board
- 6 Keyboard / LCD- display
- 7 General power supply input, filter
- 8 Ventilation

- 14 Coupling capacitors for surge mode
- 15 High voltage switch for burst mode
- 16 Power switches for voltage dip mode PF1, PF2
- 17 Current sensor

- 21 Measuring and control output
- 22 Input for the power mains supply of the EUT
- 23 Output for the EUT supply

## 6. Technical data

### 6.1. EFT Electrical Fast Transients Burst as per IEC 61000-4-4

Test Level	M4 Type, UCS 500 upgrade	M6/M6A Type	
Open circuit *	200V - 4400V $\pm$ 10%	200V – 5500V $\pm$ 10%	
Wave shape into a 50 $\Omega$ load	100V – 2200V	100V – 2750V	
Rise time tr	5ns $\pm$ 30%	5ns $\pm$ 30%	
Pulse duration td	50ns $\pm$ 30%	50ns $\pm$ 30%	
Wave shape into a 1000 $\Omega$ load	200V – 4400V	200V – 5500V	
Rise time tr	5ns $\pm$ 30%	5ns $\pm$ 30%	
Pulse duration td	35ns - 150ns	35ns - 150ns	
Source impedance	Zq = 50 $\Omega$ $\pm$ 20%	Zq = 50 $\Omega$ $\pm$ 20%	
Polarity	Positive / negative	positive / negative	
<b>Trigger</b>			
Trigger of bursts	AUTO, MANUAL, EXTERN		
Synchronization	0° - 360°		
Burst duration td	0.10ms - 999.9ms		
Burst repetition rate tr	10ms - 9999ms		
Spike frequency f	0.1kHz – 1000kHz	Range	Step
		< 10 kHz	0.1 kHz
		10 – 100 kHz	1.0 kHz
		100 – 250 kHz	10.0 kHz
		> 250 kHz	50.0 kHz
Test duration T	0:01 min - 99:59 min		
<b>Output</b>			
Direct via 50 $\Omega$ coaxial connector	To connect ext. coupling devices		
Coupling network	To L, N, PE all combinations		
DUT power mains supply	AC 250 V / 16 A / 50/60 Hz		
	DC 250V/10A		
<b>Test routines</b>			
Quick Start	Immediate start, all parameters adjustable during a running test		
Standard test as per	IEC 61000-4-4 level 1		
	IEC 61000-4-4 level 2		
	IEC 61000-4-4 level 3		
	IEC 61000-4-4 level 4		
	EN 61000-6-1 Generic		
	EN 61000-6-2 Generic		
	IEC 61000- 4-4 Manual operated standard test routine		
User test routines	Synchronous burst release		
	Random burst release		
	Change level V after T by steps of dV		
	Frequency sweep in one single burst		
	Frequency sweep with constant pulses		
	Frequency sweep, constant burst duration		
	Change polarity after T		

\* With Burst pulses as per. IEC 61000-4-4 Ed2 : 2004 the max. output voltage can be limited.

## 6.2. SURGE Immunity requirements as per IEC 61000-4-5

Test level	M4, UCS 500 upgrade	M6/M6A		
Open circuit voltage	160V - 4000V $\pm$ 10%	250V - 6600V $\pm$ 10%		
Wave shape				
Rise time tr	1,0 $\pm$ 30%	1,0 $\pm$ 30%		
Pulse duration	50 $\mu$ s $\pm$ 20%	50 $\mu$ s $\pm$ 20%		
Short circuit current	80A - 2000A $\pm$ 10%	125A - 3300A $\pm$ 10%		
<b>Wave shape</b>				
Rise time tr	6.4 $\pm$ 20%	6.4 $\pm$ 20%		
Pulse duration	16 $\mu$ s $\pm$ 20%	16 $\mu$ s $\pm$ 20%		
Polarity	Pos., Neg., Alt	Pos., Neg., Alt		
Repetition rate	max. 1Hz (1s* - 999s)	max. 0.5Hz (2s* - 999s)		
Events preselection	1 - 30'000 or endless	1 - 30'000 or endless		
Counter	1 - 1000000	1 - 1000000		
<b>Trigger</b>				
Trigger of pulses	AUTO, MAN, EXTERN	AUTO, MAN, EXTERN		
Synchronization	0 - 360°	0 - 360°		
Resolution	1°	1°		
<b>Measurements</b>				
CRO	5V Trigger	5V Trigger		
CRO $\hat{U}$	10Vp at 4kV	10Vp at 6.6kV		
CRO $\hat{I}$	10Vp at 2kA	10Vp at 3.3kA		
Peak voltmeter	4000V	6600V		
Peak current meter	2000A	3300A		
<b>Output</b>		<b>M4</b>	<b>M6</b>	<b>M6A</b>
Direct	HV-coaxial connector; Zi = 2 $\Omega$	X		
	HV-Banana connector, Zi = 2 $\Omega$		X	X
Coupling network	L – N with Z = 2 $\Omega$	X	X	X
	L-PE, N-PE, L+N-PE with Z = 12 $\Omega$	X	X	X
	L-PE, N-PE, L+N-PE with Z = 2 $\Omega$			X
DUT supply	AC 250V / 16A / 50/60 Hz	X	X	X
	DC 250V / 10A	X	X	X
<b>Test routines</b>				
Quick Start	Immediate start, all parameters adjustable during a running test			
Standard test routines as per	IEC 61000-4-5 level 1			
	IEC 61000-4-5 level 2			
	IEC 61000-4-5 level 3			
	IEC 61000-4-5 level 4			
	EN 61000-6-1 Generic			
	EN 61000-6-2 Generic			
	IEC 61000-4-5 Manual operated standard routine			
User test routines	Change polarity after n pulses			
	Change coupling mode after n pulses			
	Change voltage level V after n pulses by $\Delta V$			
	Change phase angle A after n pulses by $\Delta A$			
Magnetic field test	test routine as per IEC 61000-4-9			
	test level 100, 300 and 1000A/m			
	cont. adjustable within Quick Start			

### 6.3. Power Fail Generator as per IEC 61000-4-11

<b>EUT supply</b>	
Channel PF1 and PF2	
AC voltage/current	max. 250V/16A
Mains frequency	50/60 Hz
DC voltage/current	max. 250V/16A
Inrush current	more than 500A
Protection	Electronic fuse for continuous overcurrent / inrush currents Electronic control of overheating PF1 and PF2 are safe against short circuit
<b>Trigger</b>	
Events trigger	AUTO, MAN, EXTERN
Repetition rate	0.01 - 99s
Synchronization	0° - 360°
Resolution	1°
Duration of events	100µs - 9900ms
<b>Measurements</b>	
DUT supply	AC/DC voltage in the LCD display
BNC output MON U	Measurement of the EUT supply
BNC output MON I	divider ratio 1:100 +/- 10%
	Measurement of the EUT current and the inrush current 10mV/A, max. 1000A
CRO TRIGGER	positive going flank
0-10V Control Output	0-10V DC for external voltage source
<b>Test routines</b>	
Quick Start	Immediate start, all parameters adjustable during a running test
Standard test routines	as per IEC 61000-4-11      ac power ports as per IEC 61000-4-29      dc power ports as per IEC 61000-6-1      Generic as per IEC 61000-6-2      Generic Manual operated standard test routine
User test routines	Voltage variation, external variac control Change phase angle W after n events by dW Change events duration td after n events by dtd Inverse mode
Magnetic field test	test routine according to IEC 61000-4-8 test level 1, 3, 10 and 30A/m with MC 2630 and a variac test level 100, 300 and 1000A/m with MC26100

#### Magnetic field tests per IEC 61000-4-8 and -9

The test routines for handling the magnetic field tests are included in the internal UCS 500M firmware. All functions to control external options as voltage/current sources or magnetic field antennas are included. In addition the following hardware is required:

#### Option required for Magnetic Field Test per IEC 61000-4-9

- Magnetic field antenna (square 1mx1m coil MS 100)
- Adapter for connecting the square coil to the surge output.

#### Option required for Magnetic Field Test 50/60Hz per IEC 61000-4-8

- External variac (MV2616) and magnetic field antenna (square 1mx1m coil MS 100)
- External current transformer (MC2630) to test 1, 3, 10 and 30A/m levels
- External current transformer (MC26100) to test level 100, 300 and 1000A/m levels (short term).



#### 6.4. ESD as per EN 61000-4-2, EN 61000-6-1/2, IEC 61000-4-2, IEC 801-2

<b>Air discharge mode</b>	
Discharge unit type P18	
Test voltage	1 – 16.5kV
Discharge capacitor	150pF ±10%
Discharge resistor	330Ω ±10%
Polarity	positive/negative
Holding time	> 5s
<b>Contact discharge mode</b>	
Discharge unit type P18	
Test voltage	1 - 8kV
Discharge capacitor	150pF ±10%
Discharge resistor	330Ω ±10%
Polarity	positive/negative
<b>Trigger</b>	
Single	Single discharge
Continue	Multiple discharges, controlled by the operator
Auto	Automatic discharge controlled by the mainframe
Repetition rate	max 10Hz, free selectable
Discharge mode	Air- or contact discharge selectable
Preselector counter	Preselection of the desired numbers of discharges
Beeper ON/Off	acoustical signal at each discharge
	Contact discharge and single air discharges
<b>Test routines</b>	
Quick Start	Immediate start, all parameters adjustable during a running test
Standard Test Routine	as per IEC 61000-4-2

Rise time of the discharge current		0.7ns - 1.0ns	
Test voltage	First peak value	Current at 30ns	Current at 60ns
2 kV	7.5 A	4.0 A	2.0 A
4 kV	15.0 A	8.0 A	4.0 A
6 kV	22.5 A	12.0 A	6.0 A
8 kV	30.0 A	16.0 A	8.0 A

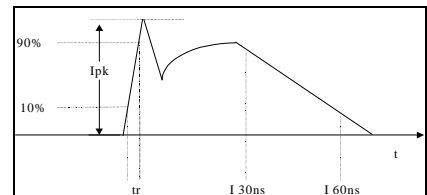

#### 6.5. General Specifications

Mains supply	230V/115V, 50/60Hz
Power consumption	110W
Fuse	230V : 2 AT slow blow 115V : 4 AT slow blow
<b>Safety</b>	
Safety circuit	External interlock capability
Warning lamp	voltage free contact max. 250V 5A
Design	per IEC 1010, EN 61010
<b>Interfaces</b>	
Serial RS 232	1200 - 19200 Baud
Parallel IEEE	Address 1-31
Analog output	0-10V DC, to control an external power supply
<b>Dimensions</b>	
Weight	19" / 3 HU app. 25 kg

=> Not relevant data for the standards can be changed by the manufacturer <=

## 6.6. UCS 500 upgrade version

Upgraded UCS 500 have the same specifications as UCS 500 M4 exception the following items.

### Warning lamp

The warning lamp connection is not potential free like the other UCS models. The power supply is delivered by the internal 24V supply.

EM Test recommends to use a relays for control the external powered warning lamps.

Voltage : 24V dc

Max. load : 200mA

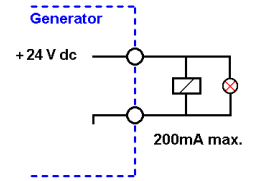

### Synchronisation

The phase synchronisation is referred to the default channel.

### ESD Option

Construction-conditioned the ESD option is not retrofittable.

### Inrush current

The upgrade version has no inrush current function.

## 7. Maintenance and service

### 7.1. General

The generator is absolutely maintenance-free by using a solid state semiconductor switch to generate transients

### 7.2. Test set- up



When setting up the test national and international regulations regarding human safety have to be guaranteed.

It is recommended to connect the simulator to the ground reference plane of the test set-up.

The generators of the series 500, UCS, VCS, CSS, TSS and CNI, can be linked together to a fully automotive test set-up.

The set-up communicates via the IEEE / GPIB bus and is controlled by ISMIEC software. For setting up the system see the following figures:

Each generator can be operated individual as a single equipment.

### 7.3. Calibration and verification

The EM Test equipment are calibrated in the factory and marked with a calibration-tag. The measuring instrument is traceable to the Swiss Federal Office of Metrology.

The calibration date is marked. The validity of the calibration is in the area of responsibility of the users quality system.

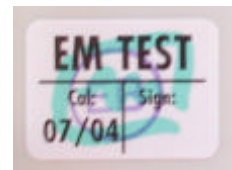

Example: EM Test calibration-tag

Please refer to the corresponding standard before proceed a calibration or verification. The standard describes the procedure, the tolerances and the necessary auxiliary means. There are suitable calibrations adapters to use. All calibrations and verifications are always without mains supply voltage on the impulse- or coupling network output.



**Danger**

Before starting the calibration or verification  
**remove the EUT Mains Supply**  
 from the generator and from the coupling network

## 8. Delivery Groups

### 8.1. Basic equipment

- Generator type UCS 500M4/M6/M6A with recommended modules ( Burst, Surge, Power Fail, ESD)
- Mains cable
- Mains cable for the EUT supply
- Adapter for power cable
- Manual
- Calibration certificate

### 8.2. Accessories and options

#### Burst

- Capacitive coupling clamp as per IEC 61000-4-4 to couple the fast transients to signal and data lines
- ITP immunity test set for radiation
- 50  $\Omega$  matching resistor with integrated attenuator (1:100) type KW 50
- 1000  $\Omega$  matching resistor with integrated attenuator(1:1000) type KW 1000
- Attenuator 6 dB / 50  $\Omega$

#### Surge

- Coupling/decoupling network as per IEC 61000-4-5 for signal lines type CNV 504/508 (4 wires and 8 wires)
- 3 phase CNV 503 up to 100A

#### Power Fail

- Transformer type V4780
- Variac MV 2616

#### Magnetic field

- Magnetic field antenna MS 100
- Current transformer MC 2630 up to 30A/m
- Current transformer MC 26100 up to 1000A/m

#### ESD

- Vertical coupling plate type VCP
- Grounding set type EAS 30
- Test table PRT

#### General for Burst and Surge

- External coupling/decoupling network 3 - phase CNI 503
  - EUT mains supply 400 V rms max. // 480V for USA
  - Nominal current  $I_n = 16 \text{ A} / 32\text{A} / 63\text{A} / 100 \text{ A rms}$
  - Frequency 50/60 Hz
  - Coupling to all lines, N, PE
  - 50 $\Omega$  Burst output The coupling will be controlled by the UCS 500 or EFT 500
  - Output for Surge coupling to other coupling networks as CNV types ...

#### Software "ISM\_IEC"

- Test and documentation under Windows (see separate documentation)

## 9. EFT Burst as per IEC 61000-4-4

Burst Module 5/50ns

### 9.1. Operation

The Burst menu offers different test routines for burst testing.

Burst	IEC 61000-4-4
F1 : Quick Start	
F2 : Standard test routines	
F3 : User test routines	

F1 F2 F3 F4 F5 F6 F7

#### F1 Quick Start

Easy and fast online-operation of the equipment.

#### F2 Standard test routines

The operator can select between various preprogrammed test routines as required in different standards

#### F3 User test routines

The operator can select between various preprogrammed test routines which helps to accelerate testing and which are very helpful especially during design.

#### 9.1.1. Quick Start

Easy and very fast operation of all standard functions of the equipment. The latest simulator settings are stored automatically and will be recalled when Quick Start is next selected.

Burst		Quick start
V = 500V	f = 5kHz	
td = 15ms	tr = 300ms	
cpl = L	+/- = +	
T = 01:00min		

START CHANGE

F1 F2 F3 F4 F5 F6 F7

Press **CHANGE** and the test parameters parameter can be changed.

Select the desired parameter with the related function key and change the value by turning the front panel knob. The cursor allows the user to define the digit to be changed (fast or slow change).

Press **START** and the test starts immediately with the displayed test parameters.

The operator now can navigate with the **Cursor** from parameter to parameter. The blinking parameter can be changed by turning the front panel knob.

Press **ESC** will bring the user back to the previous menu level. All function keys except F2 (manual trigger) can **Stop** the test routine.

#### Burst specification as per IEC 61000-4-4

tr = 15ms ( 0.75ms )  
 td = 300ms  
 f = 5kHz ( 100 kHz )

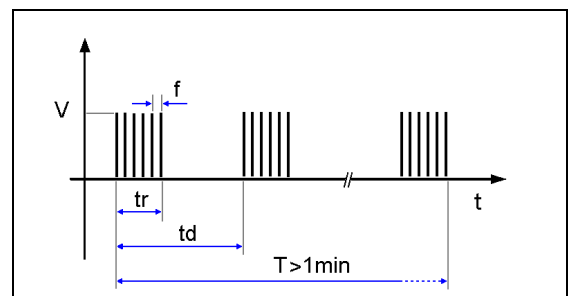

### 9.1.2. Standard test routines

The user can select preprogrammed standard test routines.

#### Page 2

Burst Standard test routines		
F1	: IEC 61000-4-4	Level 1 500V
F2	: IEC 61000-4-4	Level 2 1000V
F3	: IEC 61000-4-4	Level 3 2000V
F4	: IEC 61000-4-4	Level 4 4000V
F5	: EN 61000-6-1	Generic 1000V
F6	: EN 61000-6-2	Generic 2000V
F7	Manual test routine	

F1 F2 F3 F4 F5 F6 F7

#### Page 3 (Show parameters and start the test)

Burst	IEC 61000-4-4	Level 3
V	= 2000 V	f = 100 kHz
kop = COM		
START CHANGE		

F1 F2 F3 F4 F5 F6 F7

T	:	00:01 min	99:59 min
f	:	5.0 kHz	100 kHz
cpl	:	COM	/ ALL
1:00	T	f	cpl
	100	COM	

F1 F2 F3 F4 F5 F6 F7

The function „**Change**“ enables the operator to switch between 5kHz/100kHz spike frequency. The burst duration will be automatically matched to 15ms respectively 0.75ms.

The coupling mode can be setted depends the Standard version ( ALL 1994 / COM 2004 )

Additionally the operator can enter the required test time.

#### Manual standard test routine

Burst	Standard routine	IEC 61000-4-4
<- ->	O	
Level 3	+ 2000V	L N 5.0 kHz
		Testtime 0:00:45 h
START	+/- L N PE	L N PE f

F1 F2 F3 F4 F5 F6 F7

Within this test routine all standard parameters can be changed online during testing. This procedure therefore is very easy and fast to use.

By pressing the function „f“ the operator can select between 5kHz and 100kHz spike frequency. The burst duration will be automatically matched to 15ms respectively 0.75ms.

#### Example:

- By pushing the cursor ←→ the test level will be increased/decreased to the next standard level.
- By turning the INC knob (o) the test level can be continuously adjusted.
- Pressing the function keys the related function will be immediately activated.
- The displayed time will be resetted to zero after every new setting.

All functions can be operated during the running test.

### 9.1.3. User Test Routines

The user can program, save and recall his own specific test routines. The next pages shows the selection of the functions.

USER TEST ROUTINES						
F1	:	Synchronized				
F2	:	Random burst release				
F3	:	Voltage change after T by				
F4	:	Frequency sweep in one single burst				
F5	:	Frequency sweep with constant pulse numbers				
F6	:	Frequency sweep with constant burst duration				
F7	:	Change polarity +/- after T				

F1      F2      F3      F4      F5      F6      F7

After selection the last used test parameters will be indicated on the display.

#### Customized test routines

The software controls user test routines according to the specification of the user. All limitations are the same as defined under Quick Start.

#### Synchronized with a fixed phase angle

The burst is triggered with respect to the phase angle of the power supply connected to the Sync input at the rear panel of the equipment. The power supply must be an AC voltage with a nominal frequency of 16 to 500Hz. The phase must be connected to L. This can be checked by the lamp connected to the L input.

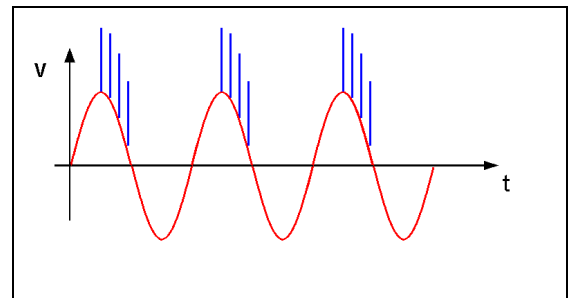

#### Random burst release

No repetition rate is selected. The single burst will be triggered by statistics in the limits of 20 to 2000ms as time between two bursts. All limitations are the same as defined under Quick Start.

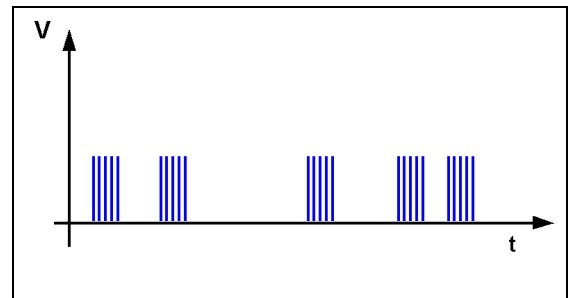

Voltage change after T by  $\Delta V$  The test voltage is increased from  $V_1$  to  $V_2$  by steps of  $\Delta V$  after the defined test time T. All limitations are the same as defined under Quick Start. The limitation of the max. generated number of spikes is related to the higher voltage of  $V_1$  or  $V_2$ .

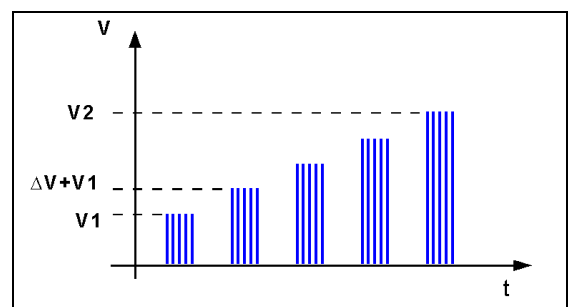

### Frequency sweep in one single burst

During one single burst the frequency sweeps from  $f_1$  to  $f_2$ .  
For this function the following limitations have to be respected:

$t_r$	$\geq$	100 ms
$f_1$	$\leq$	$f_2$
$t_d$	$\geq$	5.0 ms
$t_d$	$\geq$	$5 / f_1$
$t_r - t_d$	$\geq$	50 ms

Note: The maximum value for frequency, burst duration  $t_d$  and voltage are in dependence of each other and therefore limited by the generator performance. The practical limits of the UCS500 M6 are 20kHz for  $f_2$  and 50ms for the burst duration  $t_d$ . The limits of the generator model UCS 500 M4 are approx. 10 times higher.

### Frequency sweep with a constant pulse numbers

The burst duration is increased from  $t_{d1}$  to  $t_{d2}$  by steps of  $\Delta$   $t_d$  after the defined test time  $T$ . All limitations are the same as defined under Quick Start. The limitation of the max. generated number of spikes is related to the higher duration of  $t_{d1}$  or  $t_{d2}$ .

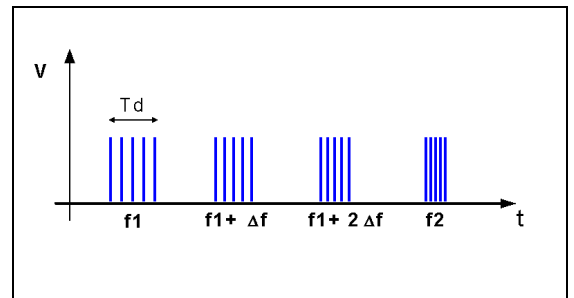

### Frequency sweep with a constant duration after T by $\Delta f$

The spike frequency is increased from  $f_1$  to  $f_2$  by steps of  $\Delta f$  after the defined test time  $T$ . All limitations are the same as defined under Quick Start. The limitation of the max. generated number of spikes is related to the higher frequency of  $f_1$  or  $f_2$ .

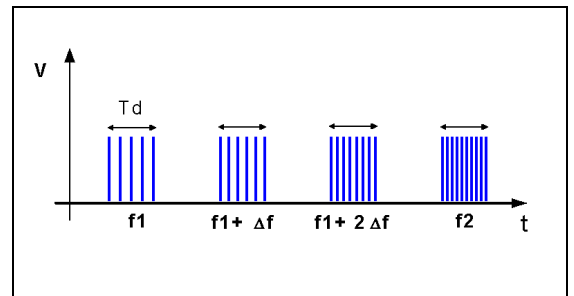

### Polarity change after T

The polarity will be changed from + to - after the defined test time  $T$ .

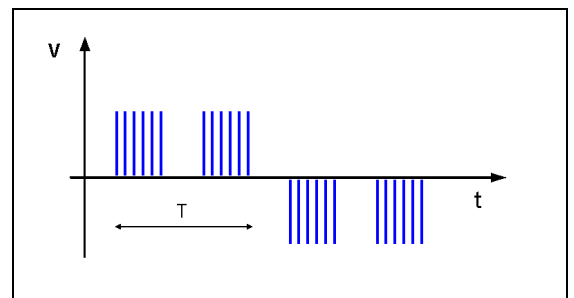



## 9.2. Burst generation

### Discharge switch:

The discharge switch is a highly reproducible semiconductor switch. Spike frequencies up to 1000kHz are by a factor of 200 higher than recommended in the actual EFT standards. This means of course that also the pulse energy would be 200 times higher. This is not generally possible for the high voltage switch. Therefore the following limitation protects the pulse forming circuit against overload:

M4 Type

Voltage U	max. pulse / burst td * f	max. pulse / s td * f / tr	
< 1'500V	1,000	10,000	
>= 1'500V < 2'500V	1,000	linear decrease to 5,000	
>= 2'500V	linear decrease to 500	linear decrease to 1,500	

M6/M6A Type

Voltage U	max. pulse / burst td * f	max. pulse / s td * f / tr	
< 4'000V	100	1,000	
>= 4'000V < 5'000V	linear decrease to 88	linear decrease to 750	
>= 5'500V	linear decrease to 75	linear decrease to 500	

## 9.3. Test level with Burst as per IEC 61000-4-4 Ed.2.

Burst generators, which the specifications in accordance with IEC 61000-4-4 Ed2: 2004 fulfills, have a limitation of the maximum output voltage. The efficiency of the Burstpuls decreases with the numbers of couplings.

Therefore the maximum test level is limited by the number of coupling on several lines.

Generators with the modification in accordance with IEC 61000-4-4 Ed2: 2004 the. max. test levels have the following limits:

Coupling	UCS 500 UCS 500M4	>Vers.3.0 >Vers.3.0	UCS 500M6 UCS 500M6A	>Vers.3.0 >Vers.3.0	UCS 500M6B
50 Ω	4400V		5500V		5500V
1 coupling any	4400V		5500V		5500V
2 couplings any	4400V		5000V		5000V
3 couplings any	4400V		5000V		5000V

Generator with CNI 503 / CNE 503	UCS 500 UCS 500M4	>Vers.3.0 >Vers.3.0	UCS 500M6 UCS 500M6A	>Vers.3.0 >Vers.3.0	UCS 500M6B
50 Ω	4400V		5500V		5500V
1 coupling any	4400V		5500V		5500V
2 couplings any	4000V		5000V		5000V
3 couplings any	4000V		5000V		5000V
4 couplings any	4000V		4500V		4500V
5 couplings any	4000V		4500V		4500V

## 9.4. Coupling decoupling network

The decoupling part of the coupling network has to:

- filter the interference pulses in the direction to the power supply;
- protect other systems that are connected to the same power supply and
- realize a high impedance of the power supply, e.g. battery supply.

### 9.4.1. Coupling/decoupling network for ac/dc power lines

The coupling network has to couple the interference pulses to the lines of a power supply system (AC or DC). As coupling devices capacitors of sufficient strength and bandwidth shall be used according to IEC 61000-4-4.

- **Normal Mode**            Line            =>    GND  
                                 Neutral        =>    GND
- **Common Mode**        Line + Neutral   =>    GND
- **Protective Earth PE**    The PE of the EUT is decoupled from the power supply side by a choke. The interference source is coupled directly to the PE of the EUT.

The decoupling part of the coupling network has two purposes:

- to filter the interference pulses in the direction of the power supply side;
- to protect other systems that are connected to the same power supply and
- to realize a high impedance of the power supply, e.g. battery supply.

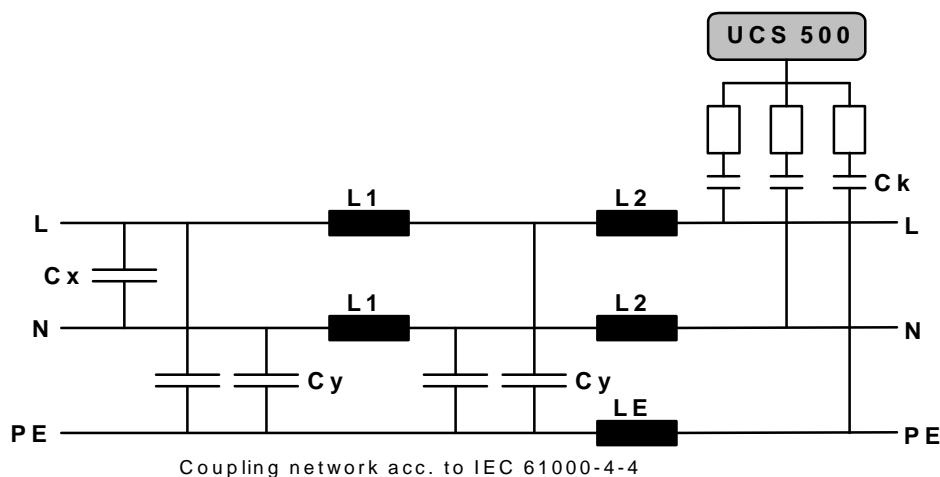

The coupling on signal lines can usually not be effected capacitively without interfering with the signal flow. It is often impossible to contact the required circuit (direct), e. g. coaxial or shielded cables. In this case the coupling is realized with the capacitive coupling clamp. The interference simulator can be connected on both sides of the coupling clamp.

#### Attention:

The actual published IEC 61000-4-4 (1995) requires all lines to be tested individually.

The new draft revision IEC 61000-4-4 edition 2 (2004) requires the Common Mode coupling only. This means all lines simultaneously to ground.

### 9.4.2. Capacitive coupling clamp

- The coupling clamp is not matched by 50 ohm. If the clamp is matched there exists an additional magnetic coupling, which may cause completely different test results.
- The clamp should be placed in a distance of 0.5m to the equipment under test. When using shorter distances, the EUT may be influenced by radiation.
- If the EUT is built up by two different equipment, the test should be conducted on each single equipment with the required distance.

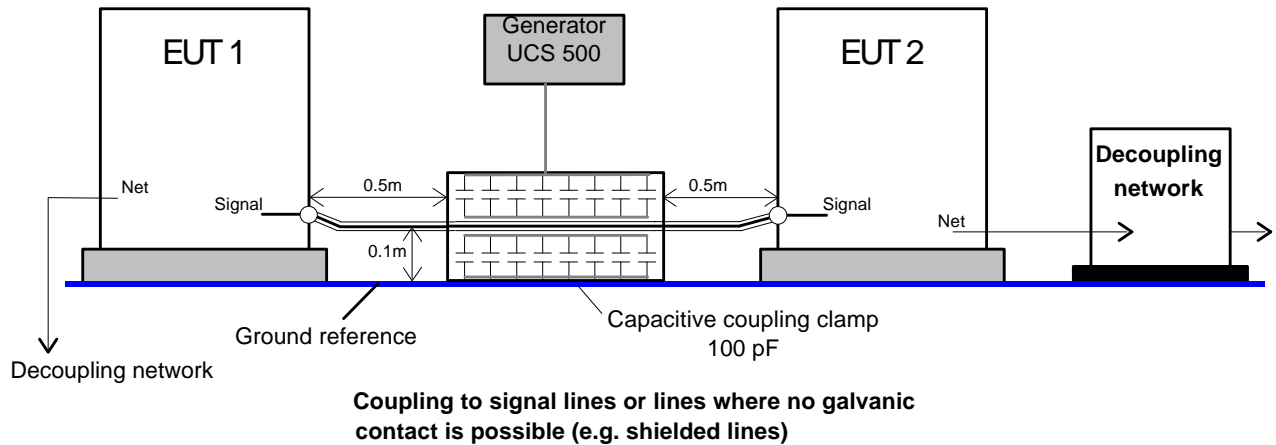

### 9.5. Burst Test Setup

- The test generator and the coupling network should be connected to the reference ground plane (acc. to high frequency requirements).
- The equipment under test must be isolated from the reference ground plane. The distance should be 10cm. Being part of the EUT, these requirements are also recommended for all connected cables. The EUT should only be grounded if this is recommended by the installation guideline. For safety reasons, the test without any ground connection should be conducted as well (at 100MHz 1m ground cable has an impedance of about 600 ohm)
- Whenever possible the test set-up and the cabling should always be the same; e.g. for testing power lines it would be possible to fix the cables on the test table for all tests in the same way.
- Lines under test and all other lines should be decoupled strictly.

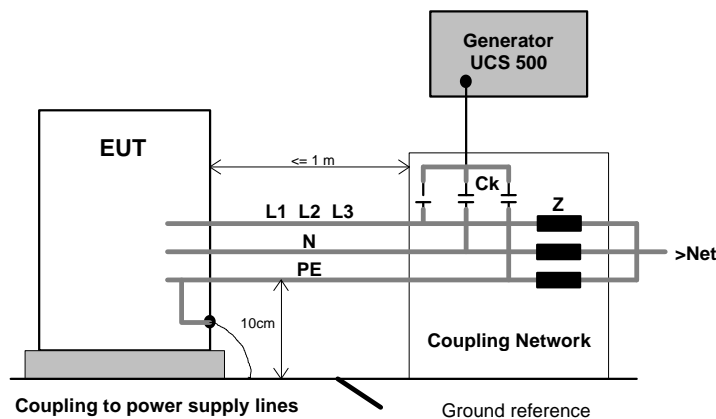

## 10. Surge Immunity as per IEC 61000-4-5

Surge Module 1.2/50 $\mu$ s – 8/20 $\mu$ s

### 10.1. Operation

The Surge menu offers different test routines for burst testing.

Surge	IEC 61000-4-5/9
F1 : Quick Start	
F2 : Standard test routines	
F3 : User test routines	
F4 : Pulse Magnetic Field	
F5 : Ring Wave	
F7 : Setup Current limiter	
F1	F2
F3	F4
F5	F6
F7	

#### F1 Quick Start

Easy and fast online-operation of the equipment.

#### F2 Standard test routines

The operator can select between various preprogrammed test routines. By pressing the related function key the test will be started automatically with the specified test parameters.

#### F3 User test routines

The operator can select between various preprogrammed test routines which helps to accelerate testing and which are very helpful especially during design.

#### F4 Pulse Magnetic Field

Within this menu the pulse magnetic field test as per IEC 61000-4-9 is supported.

#### F5 Ring Wave

Within this menu the Ring Wave test as per IEC 61000-4-12 or ANSI/IEEE is supported. An external RWG module shall be connected to the UCS 500.

The operator has to select which type of module is used. Without any setup selection the RWG module can not be used.

**For RWG operations please read the manual of the RWG 500 modules.**

#### F7 Set-up Current limiter

Within this menu the operator can select the maximum allowable surge current for the EUT. The limiter can be selected for both coupling modes, common mode (line to ground) and differential mode (line to line).

### 10.1.1. Quick Start

Easy and very fast operation of all standard functions of the equipment. The latest simulator settings are stored automatically and will be recalled when Quick Start is next selected.

Surge		Quickstart				
V	= 2000V	A	= 0 dgr			
+/-	= +	cpl	= L + N - PE			
tr	= 10s	tri	= Auto			
n	= endl					
START CHANGE						
F1	F2	F3	F4	F5	F6	F7

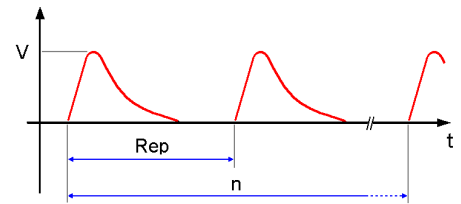

Press **CHANGE** and the test parameters parameter can be changed.

Select the desired parameter with the related function key and change the value by turning the front panel knob. The cursor allows the user to define the digit to be changed (fast or slow change).

At polarity setting ALT it is necessary to double the number of impulses. Example  $n=2 \Rightarrow$  one impulse positive and one impulse negative.

Pressing the ESC button will bring the user back to the previous level from where the test can be restarted with new levels.

Press **START** and the test starts immediately with the displayed test parameters.

All functions keys except F2 (if MAN TRIGGER is selected) can stop the test routine. The latest setting will be displayed.

Any pressing of a function key will indicate the functions START, CHANGE or CONTINUE. F3 will continue the same test routine. If the user selects at first START or CHANGE the test will be stopped completely

Press **ESC** will bring the user back to the previous menu level.

#### Page 3 (Start)

Surge		Quickstart				
V	= 2000V	A=	0 dgr			
+/-	= +	cpl	= L + N - PE			
Rep	= 10 s	tri	= Auto			
n	= endl.					
Vsoll =	2000V	U =	+ 2000V			
STOP		I =	+ 0000A			
			COUNTER			
			0000043			
F1	F2	F3	F4	F5	F6	F7

While a test is running the user can select parameters with the cursors  $\leftarrow \rightarrow$ . The selected parameter then can be changed online with the inc/dec knob.

### 10.1.2. Standard test Routine

#### Page 2

Standard test routines		
F1 : IEC 61000-4-5	Level 1	500V
F2 : IEC 61000-4-5	Level 2	1000V
F3 : IEC 61000-4-5	Level 3	2000V
F4 : IEC 61000-4-5	Level 4	4000V
F5 : EN 61000-6-1	Generic	2000V
F6 : EN 61000-6-2	Generic	2000V
F7 : Manual test routine		

F1    F2    F3    F4    F5    F6    F7

With the selection of F1 ....F6 the test is conducted automatically with the parameters and the test sequence as required per IEC 61000-4-5. The only parameters the operator is able to change are the repetition rate and the number of pulses per test level. With a faster repetition rate as required in the standard the total testing time can be reduced significantly.

#### Iteration of the standard test procedure as per IEC 61000-4-5

The surges have to be applied synchronized to the voltage phase at the respective angle and the peak value of the a.c. voltage wave (positive and negative).

The surges have to be applied line to line and line(s) and earth. When testing line to earth the test voltage has to be applied successively between each of the lines and earth.

The test voltage has to be increased by steps from the lowest test level up to the test level specified in the product standard or test plan.

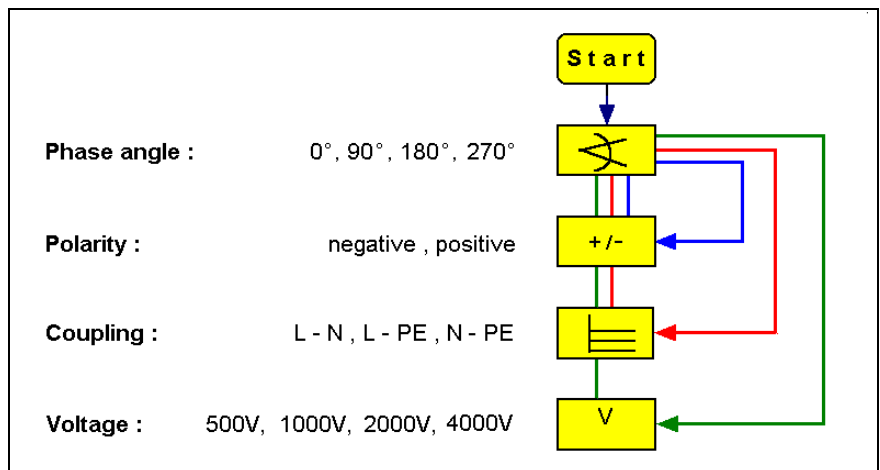

#### List of settings EN 61000-6-1 ( each setting with 5 pulses )

Setting	Voltage	Coupling	Polarity	Phase angle
1	500	L-N	pos	0
2				90
3				180
4				270
5			neg	0
6				90
7				180
8				270
9		L-PE	pos	0
10				90
11				180
12				270
13			neg	0
14				90
15				180
16				270
17		N-PE	pos	0
18				90
19				180
20				270
21			neg	0
22				90
23				180
24				270
25	1000	L-N	pos	0
26				90
27				180
28				270
29			neg	0
30				90
31				180
32				270

Setting	Voltage	Coupling	Polarity	Phase angle
33	1000	L-PE	pos	0
34				90
35				180
36				270
37			neg	0
38				90
39				180
40				270
41		N-PE	pos	0
42				90
43				180
44				270
45			neg	0
46				90
47				180
48				270
49	2000	L-PE	pos	0
50				90
51				180
52				270
53			neg	0
54				90
55				180
56				270
57		N-PE	pos	0
58				90
59				180
60				270
57			neg	0
58				90
59				180
60				270

**Standard test Routine****Page 3** (show parameters)

Surge	Generic EN 61000-4-5	
	5s	AUTO
	10 Pulse	
<b>+ 1000V</b>		
L-PE	90grd	Counter
	U=970V	000002
STOP	STEP	I = 010A 000034
<b>F1</b>	<b>F2</b>	<b>F3</b> <b>F4</b> <b>F5</b> <b>F6</b> <b>F7</b>

- The counter shows the number of triggered pulses per actual test level as well as the number of all triggered test pulses within the running test sequence.
- Pushing the function key F2 STEP will bring you into the next iteration sequence.

**Manual test routine**

Surge	Standard	IEC 61000-4-5	
<- ->	O	O	
Level3 +2000V	10s	0 grd	L-N
START +/-	O V/A	Rep	L-N L-PE N-PE
<b>F1</b>	<b>F2</b>	<b>F3</b>	<b>F4</b> <b>F5</b> <b>F6</b> <b>F7</b>

Within this test routine all standard parameters can be changed online during testing. This procedure therefore is very easy and fast to use.

**Example:**

- Operating the cursor will increase/decrease the test level to the next level required in the standards
  - By turning the inc knob the test voltage V resp. the phase angle A will be adjusted continuously. The blinking circle shows which parameter can be changed. Pressing the function „O V/A“ will change between both parameters.
  - Pressing the function keys will activate immediately the related function.
- All functions can be changed during the running test.

### 10.1.3. User Test Routines

The user can program, save and recall his own specific test routines. The next pages shows the selection of the functions.

#### User Test Routines

F1 : Change polarity after n pulses  
 F2 : Change coupling after n pulses  
 F3 : Voltage change after n pulses by  $\Delta V$   
 F4 : Change the phase angle after n pulses by  $\Delta a$

F1 F2 F3 F4 F5 F6 F7

After selection the last used test parameters will be indicated on the display.

#### Customized test routines

The software controls user test routines according to the specification of the user. All limitations are the same as defined under Quick Start.

#### F1 Change polarity after n pulses

After the release of the preselected number of pulses the polarity is changed. The procedure always starts with positive polarity and changes than to negative. The same parameters as under Quick Start can be selected.

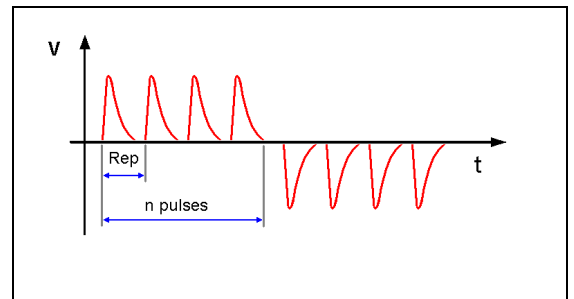

#### F2 Change coupling after n pulses

The coupling mode will automatically be changed after the preselected number of pulses has been released. All possible coupling modes will be selected. The same parameters as under Quick Start can be selected.

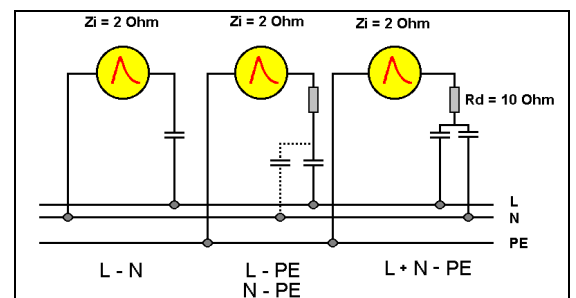

#### F3 Change test level V after n pulses by $\Delta V$

The test voltage  $V$  is changed from  $V1$  to  $V2$ . After the preselected number pulses the test level is changed by  $\Delta V$  until  $V2$  is reached. The same parameters as under Quick Start are selectable. For the limitation of the max. admissible repetition rate the higher value of  $V1$  and  $V2$  is valid.

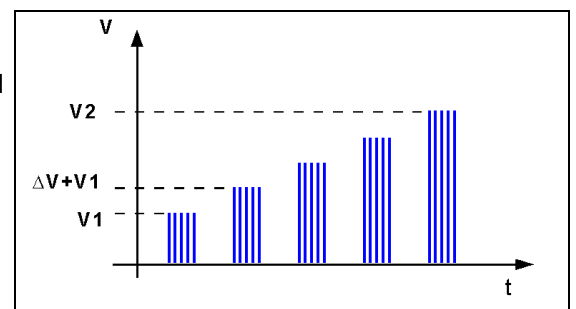

#### F4 Change the phase angle A after n pulses by $\Delta A$

The phase angle related to which the surge pulse is released is changed from  $A1$  to  $A2$ . After the preselected number of  $n$  pulses the actual phase angle is changed by  $\Delta A$  until  $A2$  is reached. The same parameters as under Quick Start can be selected.

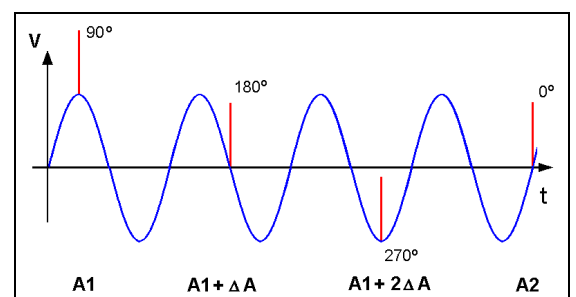



### 10.1.4. Pulsed magnetic field as per IEC 61000-4-9

#### Page 2 (Select function)

Surge Magnetic field	IEC 61000-4-9
F1 : Quick Start	
F2 : Magnetic field as per IEC 61000-4-9	
F7 : Setup magnetic field	

F1    F2    F3    F4    F5    F6    F7

The operation of the pulse magnetic field test is similar as to the standard surge routines.

#### Page 2 (show parameter)

QUICKSTART			
H	=	300A/m	A = 0 dgr
+/-	=	+	cpl = /
tr	=	10s	tri = Auto
n	=	10	
START CHANGE			

F1    F2    F3    F4    F5    F6    F7

Press **START** and the test routines begin to work.

Press **CHANGE** and the actual parameters can be changed.

**For magnetic field testing the antenna correction factor shall be included. The operator can enter this factor within the setup menu under the service routine.**

#### Setup pulsed magnetic Test field

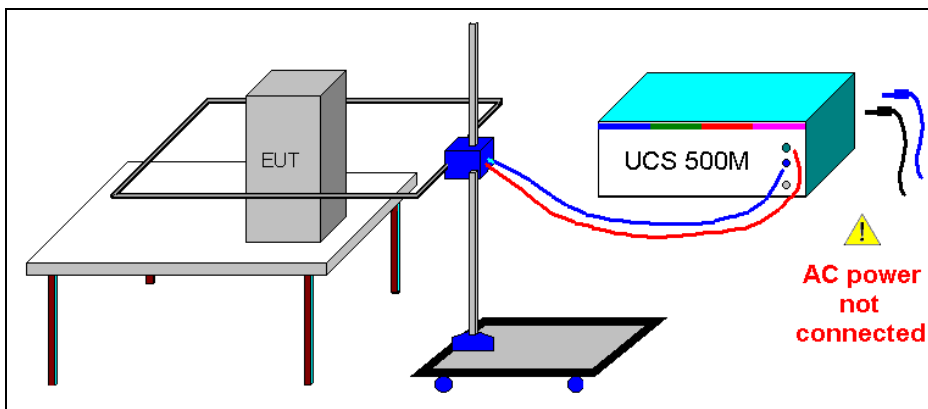

Warning

**Disconnect all power cables on the rear side at the Test supply plugs.**

**PF1, PF2 and N**

**Don't touch the antenna during the test !**

### 10.1.5. Ring Wave

For RWG application please read the operation manual of the RWG 500 modules.



RWG 500 M4



RWG 500 M6

### 10.1.6. Setup current limiter for surge current

The current limiter stops the test run when during a test the measured peak current of a surge pulse is higher than the preselected current value. This safety function protect the EUT for further surge pulses can occur any dangerous situation.

Depends of the different impedance of the surge generator, one current limiter for each impedance (2Ω, 12Ω) is available.

#### Page 2 (show parameter)

SETUP Current limiter						
F1 : I - Limiter	Differential mode C_D					
F2 : I - Limiter	Common Mode C_C					
C_D	C_C					
1000A	200A					
<b>F1</b>	<b>F2</b>	<b>F3</b>	<b>F4</b>	<b>F5</b>	<b>F6</b>	<b>F7</b>

Differential mode (line to line): The generator impedance is 2Ω

Common mode (line to ground): The generator impedance is 12Ω

Note : Surge pulses with the coupling position "V" (potential free output at the rear side of the generator ) use the settings of common mode. This is general used for the coupling network CNV 504 / 508 with 42Ω impedance. Using a coupling network CNI 503 or CNV 503, UCS uses the limits of differential and common mode.

### 10.2. Surge pulse generation

**Discharge switch:**

The discharge switch is a highly reproducible semiconductor switch.

### 10.3. Coupling decoupling network

The coupling network has to couple the interference pulses to the lines of a power supply system (AC or DC). Capacitive coupling is the specified coupling mode for surge testing.

#### 10.3.1. Coupling to ac/dc power supply lines

The surge generator UCS 500 has an integrated coupling network in accordance with IEC 61000-4-5. It must be possible to test with different coupling modes:

Line	→	GND or	(source impedance is 12Ω)
Neutral	→	GND or	(source impedance is 12Ω)
L + N	→	GND or	(source impedance is 12Ω)
Line	→	Neutral	(source impedance is 2Ω)

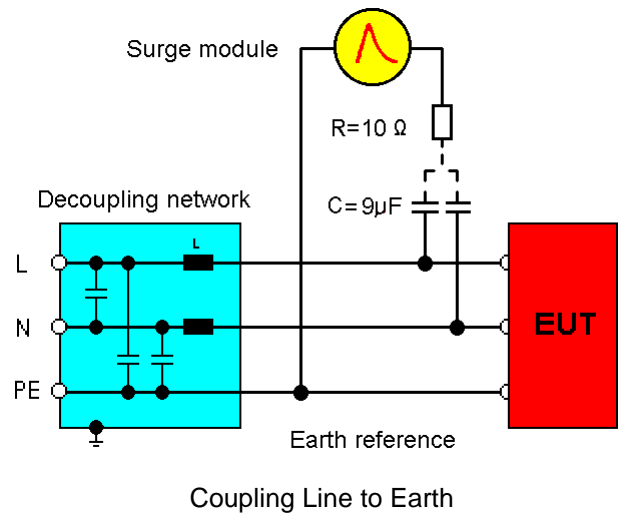
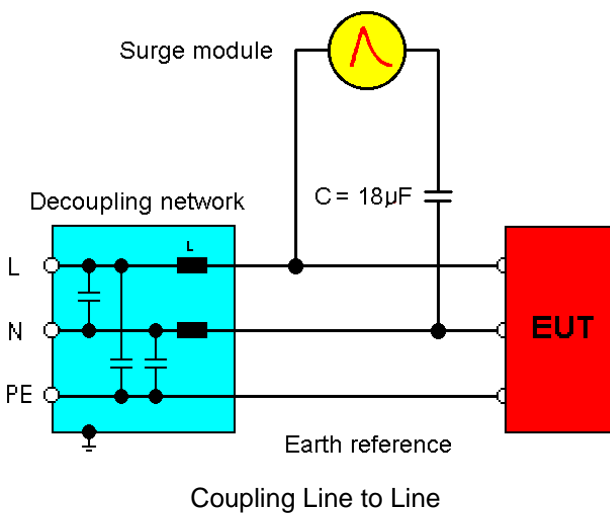

The release of the surge pulses is mostly related to a certain phase angle. The surge pulses are synchronized to the input signal at the rear Sync-connector.

#### 10.3.2. Coupling to I / O lines

The coupling to I/O lines is generally realized with other coupling networks than for power supply lines. The loading of the I/O lines with big coupling capacitors is mostly not possible. The data transmission may be disturbed. For coupling to I/O lines special couplers as per IEC 61000-4-5 are available, such as the CNV 504 and the CNV 508 for four respectively for eight wire systems.

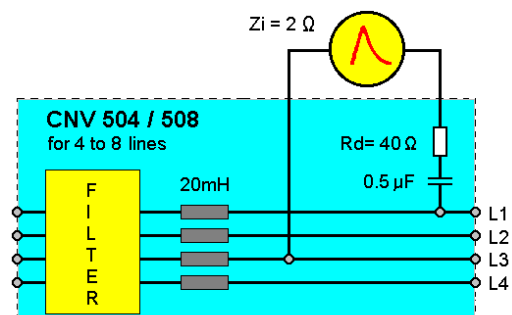

### 10.4. Test set-up

According to the specifications of IEC 61000-4-5, the surge generator has a source impedance of 12ohm when the simulator is coupled between the lines and protective earth.

This will activate fault current detectors or protectors which may be installed in the laboratory.

Therefore it is important

- not to disconnect the surge simulator form protective earth (power cable)
- to have an installation where the simulator is connected via its ground reference connector to earth

## 11. Voltage Dips as per IEC 61000-4-11

Dips Module for voltage Dips and short interruptions

### 11.1. Operation

The Surge menu offers different test routines for burst testing.

Power Fail	IEC 61000-4-11 / 8 / 29
F1 : Quick Start	
F2 : Standard test routines	
F3 : User test routines	
F4 : Magnetic field	

F1    F2    F3    F4    F5    F6    F7

#### F1 Quick Start

Easy and fast online-operation of the equipment.

#### F2 Standard test routines

The operator can select between various preprogrammed test routines as required in different standards. With the function key F4 the operator can select the standard routine for 50/60Hz magnetic field testing as per IEC 61000-4-8.

#### F3 User test routines

The operator can select between various preprogrammed test routines which helps to accelerate testing and which are very helpful especially during design.

#### F4 Magnetic Field

The operator can perform 50 / 60 Hz magnetic field test as per IEC / EN 61000-4-8.

**11.1.1. Quick Start**

Easy and very fast operation of all standard functions of the equipment. The latest simulator settings are stored automatically and will be recalled when Quick Start is next selected.

Power Fail		Quickstart	
A	= 0dgr	td	= 10.00ms
rep	= 0.50s	CH	= PF1
V2	= 250V	tri	= Auto
n	= endl.		
START CHANGE			

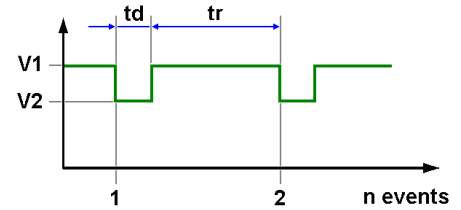

**F1 F2 F3 F4 F5 F6 F7**

Press **START** and the test routines begin to work.

Press **CHANGE** and the actual parameters can be changed.

All function keys except F2 (manual trigger) can **Stop** the test routine.

Explanations	
<b>A</b>	Phase angle
<b>td</b>	Duration of a single event
<b>Rep</b>	Repetition rate (time between two events)
<b>CH</b>	Channel select (PF1, PF2 or ΔPF)
<b>U2</b>	Variable test voltage (controlled by 0-10 V analog voltage)
<b>n</b>	Number of events
<b>tri</b>	Trigger mode

**Page 3 (Start)**

Power Fail		Quickstart	
A	= 0dgr	td	= 10.00ms
rep	= 0.50s	CH	= PF1
U2	= 250V	n	= endl.
tri	= Auto		
		V = 230 V	Counter
STOP		I = 0.5 A	002317

**F1 F2 F3 F4 F5 F6 F7**

After "**START**" the display indicates the voltage and current at the TEST SUPPLY output. The measured voltage is (V peak / 2) if there is a ac-signal on the sync input, otherwise Vpeak. The voltage dips will be repeated with the preselected repetition rate and the counter will be increased.

When the operator is using faster repetition rates the indicated voltage level is not stable. A correct value can not be displayed.

All function keys, except F2 Manual **Trigger**, can stop the running test. After Stop the last setting is displayed for about 2 seconds. Then the functions **START**, **CHANGE** or **CONT** are indicated. F3 will continue the test.

During the QUICK START procedure the value for the angle is blinking. The blinking value always and at any time can be changed by turning the knob (inc/dec). With the cursor the actual blinking function can be changed.

**Page 4 (Change)**

Power Fail		Quickstart	
A : 0dgr - 360dgr / async.			
A	td	rep	CH
0	10.00	050	PF1
		U2	tri
		250	Auto
			n
			endl.

**F1 F2 F3 F4 F5 F6 F7**

The parameter to change can be selected by pressing a function key. The corresponding range will then be displayed.

11.1.2. Standard Test Routines

Standard test routines						
F1	:	IEC 61000-4-11	(ac power supply mains)			
F2	:	IEC 61000-4-29	(dc power supply systems)			
F3	:	EN 61000-6-1	Generic standard			
F4	:	EN 61000-6-2	Generic standard			
F7 : Manual test routine						
<b>F1</b>	<b>F2</b>	<b>F3</b>	<b>F4</b>	<b>F5</b>	<b>F6</b>	<b>F7</b>

11.1.2.1. F1: IEC 61000-4-11 ( AC power supply mains )

Page 3

Power Fail	IEC 61000-4-11					
F1:	Level 1	0%	10.0 ms			
F2:	Level 2	0%	20.0 ms			
F3:	Level 3	40%	200 ms			
F4:	Level 4	70%	500 ms			
F5:	Level 5	80%	5000 ms			
F6:	Short Interruptions					
F7:	Voltage Variation					
<b>F1</b>	<b>F2</b>	<b>F3</b>	<b>F4</b>	<b>F5</b>	<b>F6</b>	<b>F7</b>

As long as the external variac MV2616 is used, controlled by an analogue 0-10V control voltage, the test is conducted automatically. If this option is not available the manual test routine shall be used.

F1 ... F5: DIPS Level 1 to Level 5

Page 4 ( Show parameter )

Power Fail	IEC 61000-4-11		Level 3
V2%	= 40%	A	= 0 dgr
td	= 200ms	tr	= 10s
		n	= 3.
			Counter
START / STOP			000002
<b>F1</b>	<b>F2</b>	<b>F3</b>	<b>F4</b>

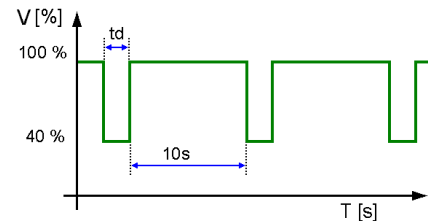

F6: Short interruptions

Page 4 ( Show parameter )

Power Fail	IEC 61000-4-11		Interruption
V2%	= 0 %	A	= 0 dgr
td	= 5000ms	tr	= 10s
		n	= 3
			Counter
START / STOP			000002
<b>F1</b>	<b>F2</b>	<b>F3</b>	<b>F4</b>

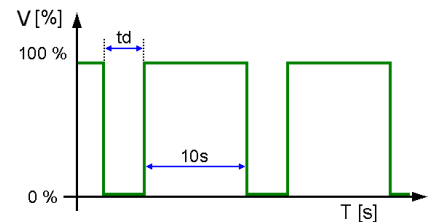

F7: Voltage Variation

Page 4 ( Show parameter )

Power Fail	IEC 61000-4-11		Variation
V2%	= 70%	A	= 0 dgr
ts	= 20ms	tr	= 10s
ti	= 0.5s	n	= 3
			Counter
START / STOP			000002
<b>F1</b>	<b>F2</b>	<b>F3</b>	<b>F4</b>

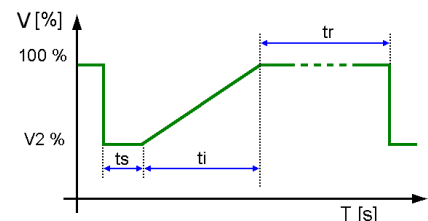

Attention: This is a new Voltage Variation function which is required in the new FDIS IEC 61000-4-11. The Voltage Variation function which is conform with the actual published IEC 61000-4-11 is available in the USER TEST ROUTINES.

**11.1.2.2. F1: IEC 61000-4-29 ( DC power supply mains )**

**Page 3**

Power Fail	IEC 61000-4-29		
F1:	Level 1	40%	10.0 ms
F2:	Level 2	40%	30.0 ms
F3:	Level 3	40%	100 ms
F4:	Level 4	40%	300 ms
F5:	Level 5	40%	1000 ms

F1 F2 F3 F4 F5 F6 F7

**F1 ... F5: DIPS Level 1 to Level 5**

**Page 4 ( Show parameter)**

Power Fail	IEC 61000-4-11		Level 3
V2% =	40%	Ch =	PF1
td =	100ms	tr =	10s
		n =	3.
START / STOP			Counter 000002

F1 F2 F3 F4 F5 F6 F7

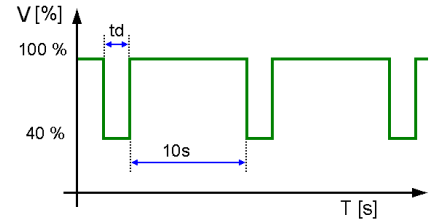

As long as the external dc supply is used, controlled by an analogue 0-10V control voltage, the test is conducted automatically. If this option is not available the manual test routine shall be used.

**11.1.2.3. F3 / F4: EN 61000-6-1 / -2 ( Generic )**

**F3...F4: Generic Test Routines**

**Page 3**

Power Fail	EN 61000-6-2		Generic
V2	td	A	n
70%	10.0 ms	0 / 180	3
40%	100 ms	0 / 180	3
40%	1000 ms	0 / 180	3
0%	5000 ms	0 / 180	3
START CHANGE			

F1 F2 F3 F4 F5 F6 F7

This test proceed automatically with a blinking status of the actual sequence in the display. As long as the external variac MV2616 is used, controlled by an analogue 0-10V control voltage, the test is conducted automatically. If this option is not available the manual test routine shall be used.

**Change parameters**

**Page 4 ( Show parameter)**

Power Fail	EN 61000-6-2		Generic
tr :	0.01 s	-	99s
tr	10		

F1 F2 F3 F4 F5 F6 F7

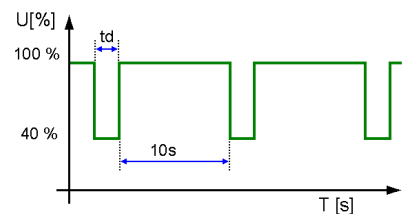

#### 11.1.2.4. F7: Manual test routine

In this menu the user can easily change the parameter online during the test.

##### Page 4 (Show parameter)

Power Fail	standard routine	IEC 61000-4-11	
<- ->	O		O
Level 4	70%	500ms	0 grd
START	oV2/td		A
F1	F2	F3	F4
F5	F6	F7	

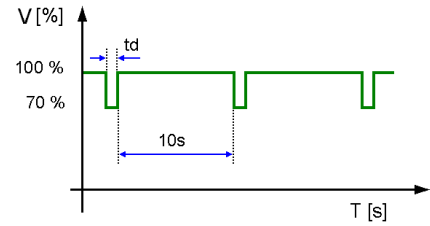

##### Example:

- Selecting the 70% level requires a 70% Vn power supply voltage at the input of PF2 at the rear panel of the UCS. Use for that the variac MV2616 (automatic), the matching transformer V4780 or your own power mains source available in your laboratory.
- By pushing the function keys will immediately activate the function
  - F1 : Start
  - F3 : oV2/td            Exchange the knob function V2Level [%] / Dip duration
  - F6 : W                 Angle 0°, 180°, asynchronous
- By turning the inc knob the duration of a single event can be adjusted.



**11.1.3. User test routines**

Page 2 (Selection)

Power Fail User test routines  
 F1 : Voltage variation as per IEC 61000-4-11  
 F2 : Change angle after n events by dA  
 F3 : Change duration after n events by dA  
 F4 : Inverse mode

F1 F2 F3 F4 F5 F6 F7

**F1 Voltage variation as per IEC 61000-4-11**

An external power source or motor driven variac is controlled by a 0-10V control signal. The operator can select the time per voltage level, the ramp up and ramp down of the voltage change and the voltage levels itself.

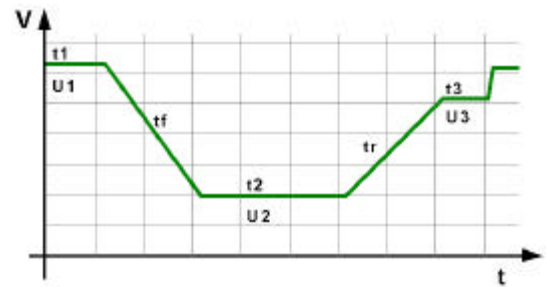

**Page 2 (show parameters)**

QUICKSTART  
 V1 = 220 V      T1 = 10 s  
 V2 = 120 V      T2 = 1 s  
 V3 = 220 V      T3 = 10 s  
 Tf = 2.0 s      Tr = 2.0 s  
 tri = AUTO      n = 00010

START CHANGE

F1 F2 F3 F4 F5 F6 F7

Press **START** and the test routines begin to work.  
 Press **CHANGE** and the actual parameter can be changed.

**F2 Change angle after n events by dA**

After n events the phase angle related to which the events are released will change from A1 to A2 by steps of  $\Delta A$  until A2 is reached. The same parameters as under Quick Start can be selected.

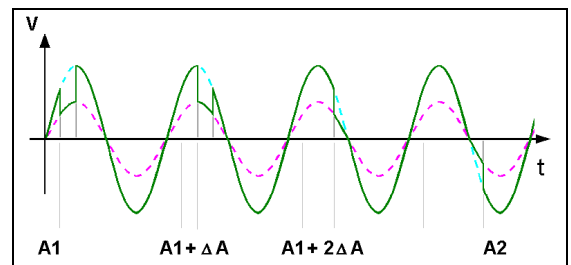

**F3 Change duration after n by Dtd**

After n events the duration of a single event will change from  $td1$  to  $td2$  by steps of  $\Delta td$  until  $td2$  is reached. The same parameters as under Quick Start can be selected.

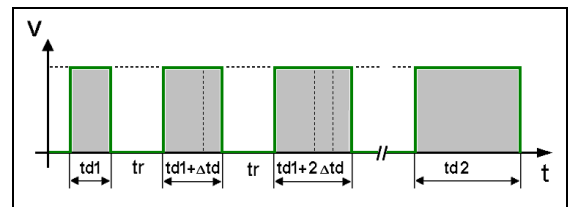

**F4 Inverse mode**

The inverse mode can simulate a phase control circuit, switching power (voltage) on/off at a certain phase angle. The phase angle is selectable in the range of 0-180°. The voltage will be switched on/off in each half-wave. Inverse is only working in **DU** mode.

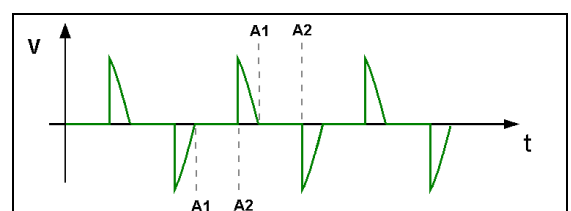

## 11.2. The Power Fail Test

PF1: The voltage supply at channel PF1 will be interrupted for the preselected time T1.

PF2: The voltage supply at channel PF2 will be interrupted for the preselected time T1.

$\Delta U$ : Channels PF1 and PF2 are supplied with different voltages; e.g. channel PF1 with nominal voltage, channel PF2 with 15% under-voltage.

- channel PF1 is switched off for the preselected time T1.
- channel PF2 is switched on for T1.

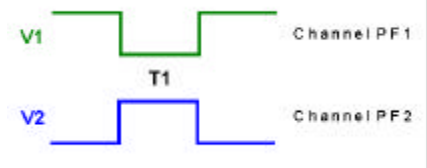

### LED

Two LED's mounted on the front panel show if a channels is active or not. The LED of an active channel is lighted. During mode  $\Delta U$  the LED display switches from one channel to the other.



### Voltage interference

In order to accelerate the test procedure the voltage interference may be generated repetitively. In the operating mode „AUTO“ the events are released at a preselected interval time.

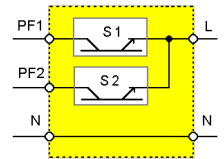

### Power switches

The power unit of the simulator consists of two electronic power switches S1 and S2. The two separated input channels PF1 and PF2 are connected to each other at the front panel of the simulator via S1 and S2.

### Input channels

The input channels PF1 and PF2 are located at the rear part of the equipment. Attention has to be given to the following:

1. **The phase shall be connected correctly. When putting into operation check the lines with a phase tester or with the incorporated LED phase.**
2. **Phase must be set on L, neutral must be set on N.**
3. **This applies to both channels. If during installation phase and neutral is changed, the operator will cause a short-circuit at the input plug of the channel.**
4. **The neutral of both channels is connected internally and directly leads to the output.**
5. **The power switches can bear no more than a voltage of 350Veff.**
6. **If isolating transformers are used special care shall be taken to have both channels in phase. Otherwise too high voltages, in difference mode, may occur and destroy the internal protection devices (varistors).**

### Power switches

The power switches are electronically protected against overload and short-circuits. The nominal current of the switches is 25A.

Special protection requirements of the EUT must be separately assured by the user.

Inrush currents of  $\leq 500A$  are permitted. To avoid higher inrush currents of the EUT an electronic control limiting the inrush current is incorporated in the device.

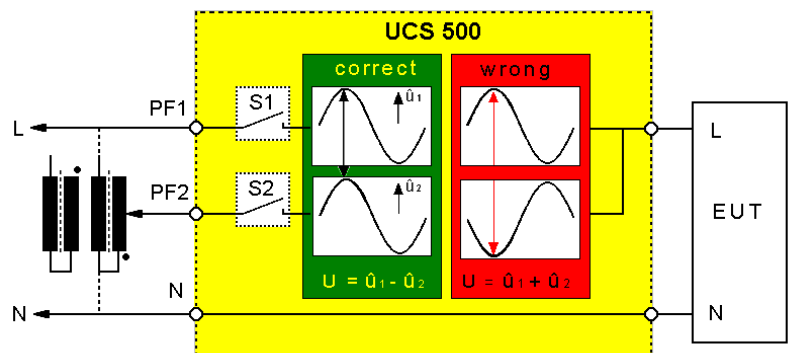

Correct phase relation between PF1 and PF2

Over-voltage generated by connecting or disconnecting additional loads will be limited internally by varistors.

### 11.3. The Power Fail Test

The generator type UCS 500 M4/M6/M6A simulates the following interference :

- Voltage dips
- Voltage interruptions
- Voltage variations
- Inverse

#### 11.3.1. Voltage Interruptions

Depending on the preselected test parameters at the front panel of the simulator the power supply for the EUT is interrupted for a certain time and at a certain phase angle (AC power supplies).

The power supply for the EUT is connected at the rear part of the simulator to channel PF1 or PF2. The same channel must be preselected at the front panel of the simulator.

The power supply may be taken directly from the mains power supply or from a separate voltage source. Mostly used for this tests are motor driven variacs

Power fail tests are normally carried out at a nominal voltage and at maximum tolerance under-voltage.

The nominal voltage may be connected to PF1 and the reduced dip voltage to PF2.

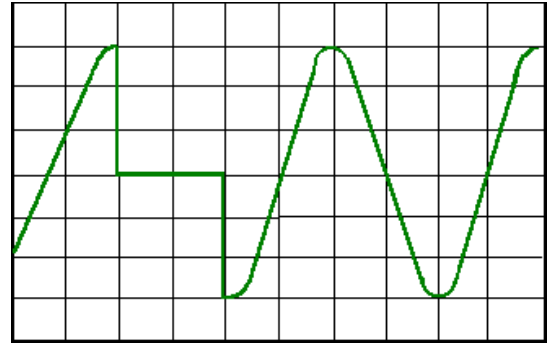

The power fail test may be carried out in various operating modes:

#### High impedance interruptions

If mode PF1 or PF2 is preselected the EUT supply is interrupted at the respective channel by the electronic switch. The EUT must discharge itself internally.

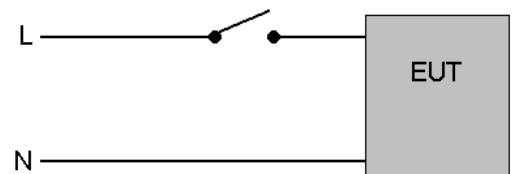

#### Low impedance interruptions

The EUT supply is connected to PF1. The channel PF2 is short-circuited (L-N). By selecting the operating mode  $\Delta U$  the EUT supply is disconnected by the electronic switch of PF1 and the EUT will be discharged into a low impedance via the electronic switch of PF2.

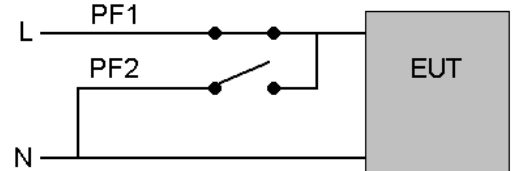

### 11.3.2. Voltage dips, voltage variations

Depending on the preselected test parameters, the test voltage is changed to a higher or to a lower value for a certain duration and at a certain phase angle.

Voltage variations are normally related to the nominal value of the supply voltage. Therefore two different variacs shall be connected at the rear side of the simulator.

- PF1 → Nominal voltage
- PF2 → Under- / overvoltage

The operation mode  $\Delta U$  shall be preselected. The voltage variation is realized by switching the power supply from channel PF1 to channel PF2.

If a motor driven variac is available, it is also possible to drive the source by an analogue voltage 0 - 10V. This control voltage is available at the coaxial output at the rear part of the simulator

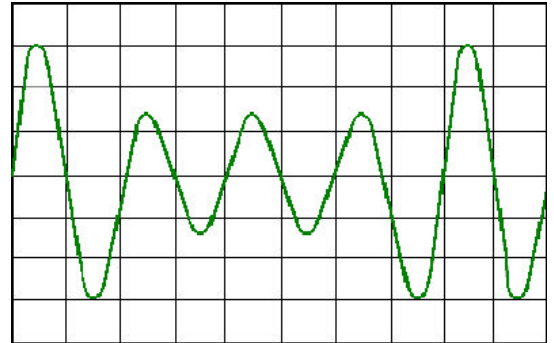

The control voltage is to be set via the operator menu or the interfaces of the PFS. A complete user software to drive ramps and functions is also available

### 11.4. DC Power networks

Basically there is no difference in the operation of the equipment between AC and DC power supplies. The only point the user should take care of are the grounding conditions.

The voltmeter, the "MONITOR" output and the LED are related to protective earth or to the simulator's chassis, respectively. Therefore these instruments can be used to check line or neutral and to measure at the output CRO U while the test procedure is running.

It results for the DC power supply operation:

- If it is possible to ground the "MINUS" pole of the DC supply, from the EUT point of view, the blue output plug (minus) should be connected to the green/yellow plug.
  - By this way the power supply source connected at the rear side of the simulator might be grounded.
- All measuring facilities are available if
- it is not possible to ground the "MINUS" pole and therefore the voltmeter cannot indicate the DC voltage.
  - the phase indication led at the EUT supply input are not glowing
  - there is no signal at the "CRO U" output.

## 11.5. Test setup and accessories

### 11.5.1. Transformer type V4780

The transformer shall be used to generate under-voltages in ac power supply systems. According to the IEC 61000-4-11 and the EN 50081-2 voltage dips shall be generated as shown in fig. below. Different test levels are recommended

#### 11.5.1.1. Voltage interruptions ( DIP )

Voltage interruptions will cause a reduction of the power supply voltage for a certain period of time. Three different test levels are required:

- Voltage dip by 100% to 0% of the nominal voltage for 10ms or. ½ period
- Voltage dip by 100% to 0% of the nominal voltage for 20ms bzw. 1 period
- Voltage dip by 60% to 40% of the nominal voltage for 200ms bzw. 10 periods
- Voltage dip by 30% to 70% of the nominal voltage for 500ms bzw. 25 periods
- Voltage dip by 20% to 80% of the nominal voltage for 5000ms bzw. 250 periods

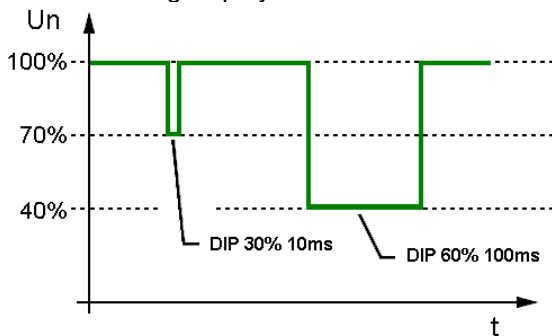

Standard voltage dips



V 4780 S2 with automatic tap control

The transformer is an accessory to the following devices

- UCS 500Mx, PFS 500

#### 11.5.1.2. Device models V 4780

V4780	250V 16A, manual control	
V4780 S1	250V 16 A manual control	additional tap at 120%
V4780 S2	250V 16A, automatic control	
V4780 S3	250V/32A, manual control	

#### 11.5.1.3. Control V4780 S2

The V4780 S2 is controlled through the analogue input ( 0...10Vdc ). The electronic switch the related tap, 40%, 70% oder 80%, proportional to the applied dc reference voltage ( 0...10V dc ) to the output PF2.

Is the reference dc voltage out of the tolerance ( $\pm 0.25V$ ), the electronic will not switch any tap to the PF2 output.

Operating with ramps the electronic will not select a tap, if the ramp ( 0-100% ) is shorter than approx. 4s. Programming longer ramptimes, each tap will switch on and off when the reference is in the valid range.

Voltage taps	DC reference voltage
80% von Unenn	8.00V $\pm$ 0.25V
70%	7.00V $\pm$ 0.25V
40%	4.00V $\pm$ 0.25V

### 11.5.1.4. Technical Data V4780

#### Design

Tapped autotransformer with 40% , 70%, 80%, 100 % output voltage

#### Input:

Voltage U<sub>in</sub>: max. 250V  
 Frequency 50/60Hz  
 Remote control 0.10V dc ( V4780 S2)

#### Output:

Voltage tap [ % Unom ]  
 120% ( V4780 S1)  
 100%  
 80%  
 70%  
 40%

	V4780, S1, S2	V4780 S3
Current I <sub>max</sub> .	16A	32A
Power	4.1 kVA	8.2 kVA
Fuse	2x 16A	2x 35A

#### Weights and measures

Dimensions	95 x 170 x 190 mm ( H x B x T )	200 x 170 x 190 mm ( H x B x T )
Weights	ca. 7 kg	ca. 14 kg
Temp Ambiance	10°C - 35°C	10°C - 35°C

### 11.5.1.5. Setup V4780

The output voltages are available at safety banana plugs. For safety reasons the related safety cables shall be used.

The power supply input is realized with a power connector for L, N and PE. The voltage shall be 100% of the nominal voltage V<sub>n</sub>. Die

Connection V 4780 / V4780 S2

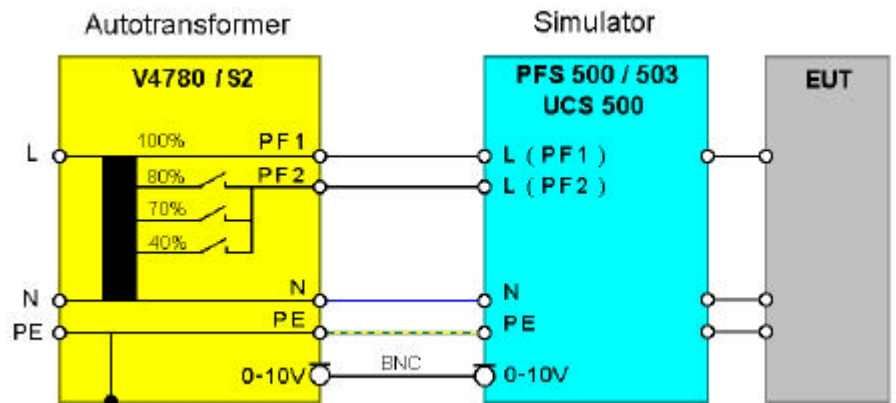

Connection V4780 S1

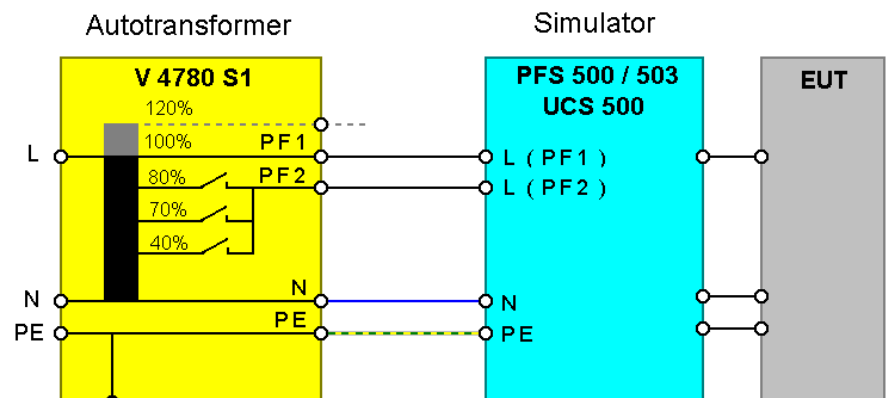

### 11.5.2. Motor variac type MV 2616

The motor variac can be used to simulate power supply failures as under-voltages, voltage interruptions and voltage variations. The basic standard IEC 61000-4-11 and the generic standard EN 50081-2 are specifying these phenomena.

#### 11.5.2.1. Voltage dips / interruptions

Voltage interruptions will cause a reduction of the power supply voltage for a certain period of time. Three different test levels are required:

- Voltage dip by 100% to 0% of the nominal voltage for 10ms or. ½ period
- Voltage dip by 100% to 0% of the nominal voltage for 20ms bzw. 1 period
- Voltage dip by 60% to 40% of the nominal voltage for 200ms bzw. 10 periods
- Voltage dip by 30% to 70% of the nominal voltage for 500ms bzw. 25 periods
- Voltage dip by 20% to 80% of the nominal voltage for 5000ms bzw. 250 periods

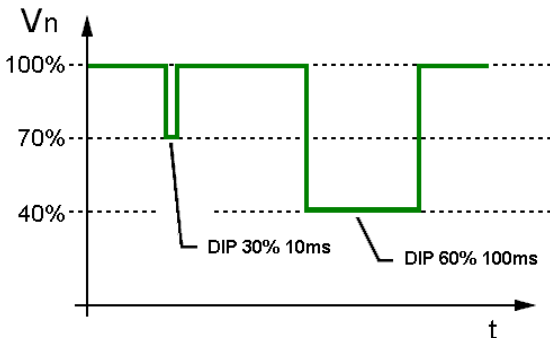

Standard voltage dips

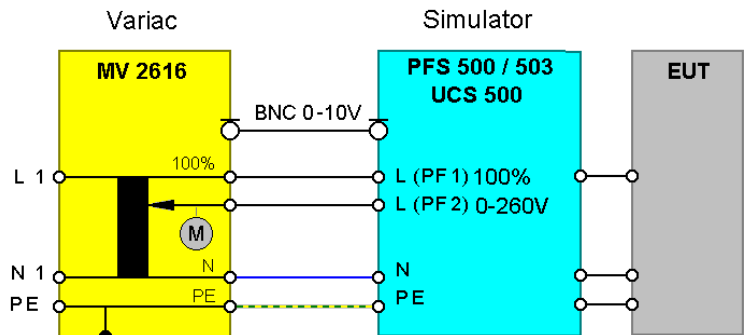

Connection diagram MV2616

The unit has to be connected at the rear part of the equipment. For connection safety laboratory cables shall be used.

#### 11.5.2.2. Voltage variation

Additionally it is possible to drive certain functions of variation, which also are required in IEC 61000-4-11. These functions can easily be programmed within the simulators itself or within the related windows software ISMIEC

V2	Test level [ %U1]:	40%, 0%
tf	Time for decreasing voltage [sec]	2 ± 20%
t1	Time at retained voltage [sec]	1 ± 20%
tr	Time for increasing [sec]	2 ± 20%

For new FDIS IEC 61000-4-11 (2004) use a new procedure for voltage variation , who simulate a voltage dip during a motor start.

The motor variac will be setted previousli to the voltage V2. The switch to PF2 happens in the UCS 500. Then the motorvariatic increase the voltage controlled by the UCS. After ti the voltage change back to PF1

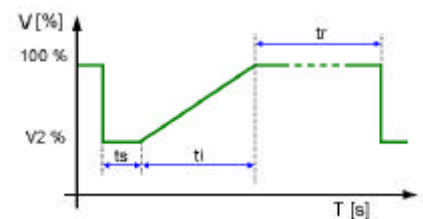
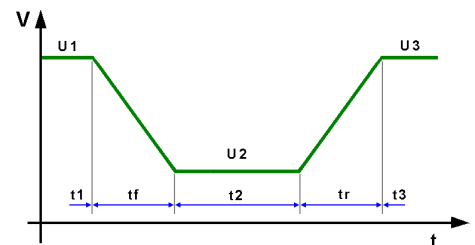

**11.5.2.3. Technical data MV 2616****Input:**

Voltage Vin: max. 250V  
Frequency 50/60Hz

**Output**

Voltage Vout: 0 - 260V for channel PF2  
additionally Vout=Vin for channel PF1  
Current max: 16A  
Power 0 - 4.1 kVA

**Control**

Main switch On/Off for the output voltages  
Control voltage analogue 0 - 10V DC for 0-260V output voltage  
Time 0..100% < 2s

**Dimensions and weight**

Dimensions 19" 6HE 266x485x400mm ( HxBxT )  
Weight app 27 kg  
Power supply 115/230V  
Fuse 20A (PF1), 16A (PF2)  
Environment Tmax 40°C





## 11.6. 50/60Hz Magnetic Field as per IEC 61000-4-8

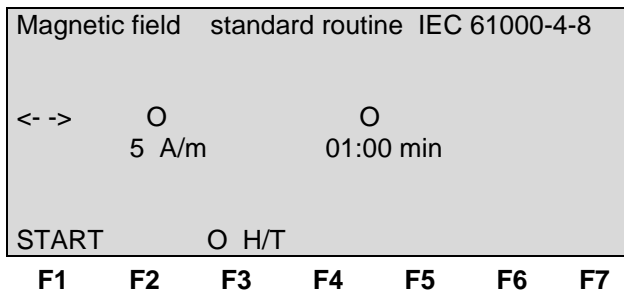

With the inc knob the values for the magnetic field strength and test duration can be changed. The actual parameter is indicated by a blinking circle.

### Test setup

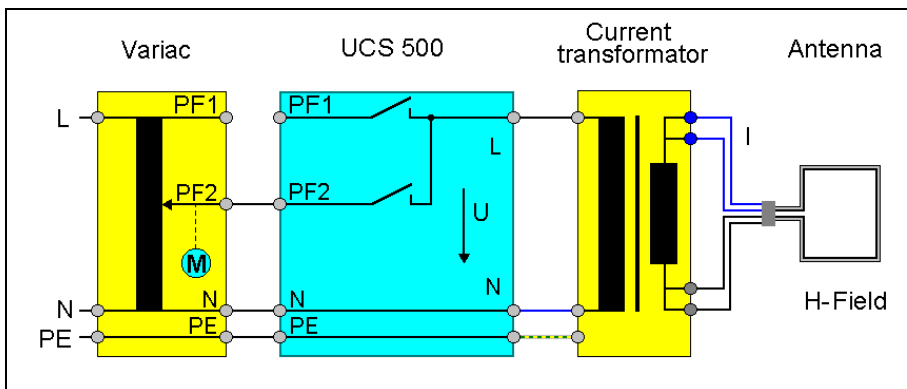
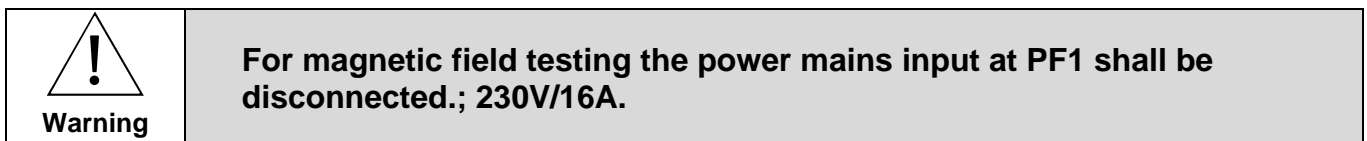

The voltage V is adjusted with a variac as long as the required antenna current is available and the related H field is generated in the center of the magnetic field antenna.

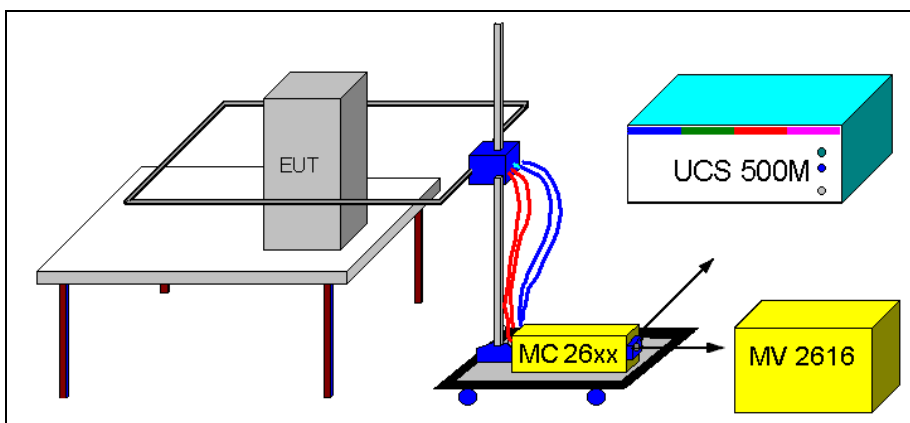

The variac, type MV 2616 may be controlled automatically via the test generator. Any equivalent variac available in the lab can be used to control the current manually. Please take care that the variac has a sufficient current capability.

**For more detailed information the operator can require an additional manual especially for magnetic field testing. This manual is part of the delivery of magnetic field testing accessories.**

## 12. Electrostatic Discharge as per IEC 61000-4-2

ESD module for electrostatic discharge

### 12.1. Operation

The Surge menu offers different test routines for burst testing.

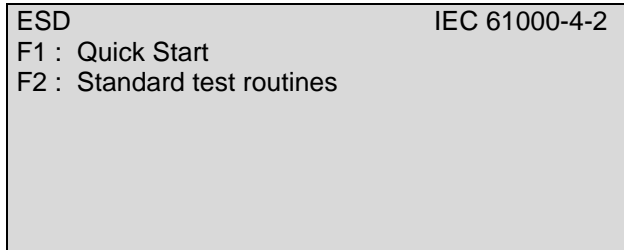

F1 F2 F3 F4 F5 F6 F7

#### F1 Quick Start

Easy and fast online-operation of the equipment.  
Standard test routines

#### F2 Standard test routines

The operator can select between various preprogrammed test routines as required in different standards.

- **Mode** Air discharge AD  
Contact discharge CD
- **Trigger** Single : Single discharge after pushing TEST ON at the P18  
CONT : Continuous discharge after pushing TEST ON at the P18  
AUTO : Continuous discharge after pushing the function key F1.

**Attention:** The TEST ON button at the P18 needs not to be pushed by using AUTO trigger. The high voltage is present after pushing the F1 Start key. This mode is for automatic testing with a handling system, where nobody is present for pushing the TEST ON button.

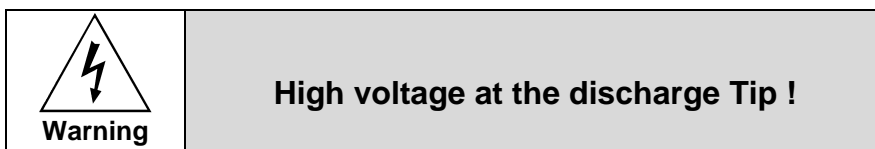

## 12.2. Quick Start

Easy and very fast operation of all standard functions of the equipment. The last simulator settings are stored automatically and will be recalled with the next selecting of Quick Start.

**Page 3** (show parameters)

ESD			Quickstart			
V	=	6000V	+/-	=	-	
Mod	=	CD	tr	=	1s	
tri	=	single	n	=	10	
START CHANGE						
F1	F2	F3	F4	F5	F6	F7

Press **START** and the test routines begin to work.  
Press **CHANGE** and the actual parameters can be changed.

## 12.3. Standard test routines

Within this test routine all standard parameters can be changed online during testing. This procedure therefore is very easy and fast to use.

**Page 3** (show parameters)

ESD		standard routine			IEC 61000-4-2	
+4000V	AD	Single	010			
						Counter
START	+/-	O	V/E	Mode	Trig	0
F1	F2	F3	F4	F5	F6	F7

### Definitions:

- **Mode**      Air discharge AD  
                 Contact discharge CD
- **Trigger**    Single : Single discharge after pushing TEST ON at the P18  
                 CONT : Continuous discharge after pushing TEST ON at the P18  
                 AUTO : Continuous discharge after pushing the function key F1.

**Attention:** The **TEST ON** button at the P18 needs not to be pushed

**O V/Ev.**      Either the **test voltage V** or the **number of events** can be selected for adjust

## 12.4. ESD Generator

### 12.4.1. Test set-up according IEC 61000-4-2

A correct test set-up is very important for a reproducible test procedure. Especially for ESD testing the correct test set-up specified in the standard is mandatory.

Some of the most important points are the following:

#### - Test table

The test must be conducted on a wooden test table. On the table, a metallic plane of at least 1,6x 0,8m must be used. The EUT shall be isolated by 0,5mm to this metallic plane, the so called horizontal coupling plane.

#### - Ground reference plane

The ground reference plane shall be located under the test table. It shall project beyond the EUT or coupling plane by at least 0,5m on all sides and shall be connected to the protective grounding system.

The horizontal coupling plane on the test table has to be connected to the ground reference plane by 2x470 k $\Omega$  resistors.

#### - Test generator

The test generator shall be located on the ground reference plane and must be well connected .

**Important: The ESD simulator shall not be located on the test table (on the horizontal coupling plane).**

The 2m long earth cable of the discharge unit shall be connected as well to the ground reference plane and not to the horizontal coupling plane.

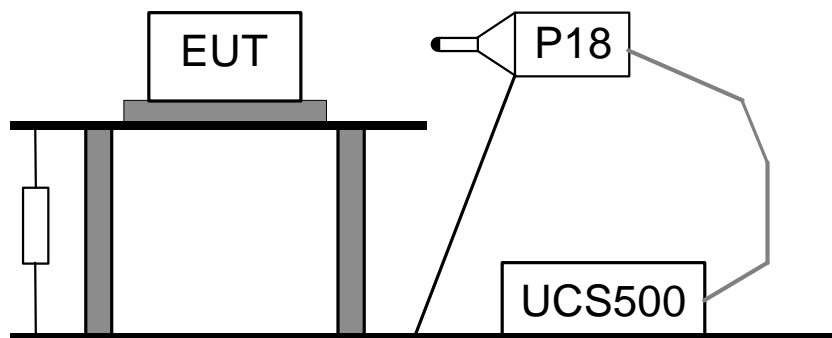

#### Attention

In case that the ESD generator is **located** also **on the test table**, it is part of the test set-up and will be automatically tested together with every EUT. Such long duration ESD tests will alter built in semiconductors and in dependence to the test time may destroy the integrated circuits.

Therefore the operator has to take care to the correct test set-up.

**12.4.2. Test application**

Both discharge methods are mandatory air- and contact discharge. Air discharges shall be applied to all points and surfaces of the EUT which are accessible to personnel during normal usage.

**Direct discharge to the EUT.**

Contact discharge shall be applied to accessible, metallic test points of EUT

It make sense to start with contact discharge and then after with air discharge. The probability to destroy the EUT with air discharge is higher, because the test voltage is higher

Direct discharges to all accessible points of the surface of the EUT : Cables, housings, display, keyboard, etc

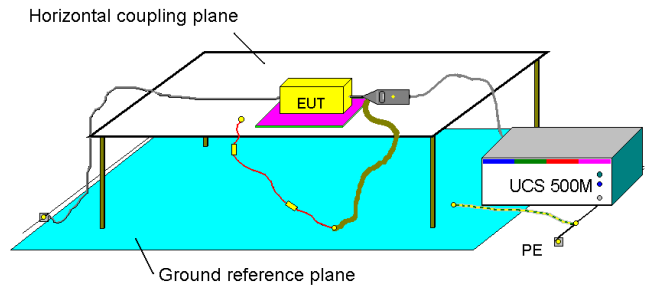

**Indirect test application to the vertical coupling plane VCP**

- At each side of the EUT
- 10cm distance to the EUT

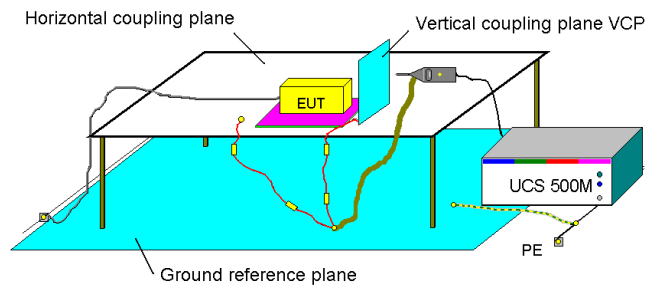

**Indirect application to the horizontal coupling plane HCP**

- At each side of the EUT
- 10cm distance to the EUT

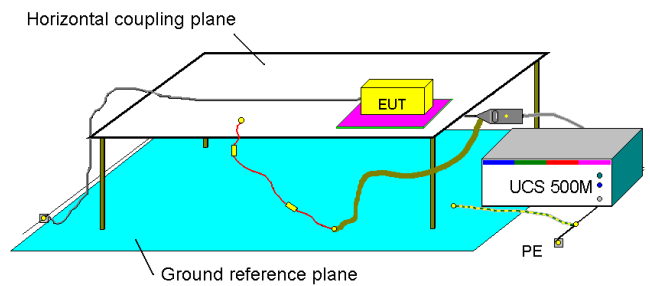

**Application for floor standing equipment**

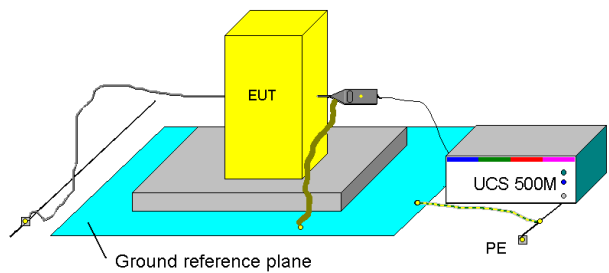

**12.4.3. Test Level IEC 61000 - 4 - 2**

Level	Contact discharge	Air discharge	Number of discharges
1	2	2	> 10 Pulses positive > 10 Pulses negative
2	4	4	
3	6	8	
4	8	15	
X	X	X	

The test voltage shall be increased from the minimum to the selected test level. All levels must be tested.

For more detailed information concerning the test setup respectively the test procedure please read the standard IEC 61000-4-2.

#### 12.4.4. Discharge Unit

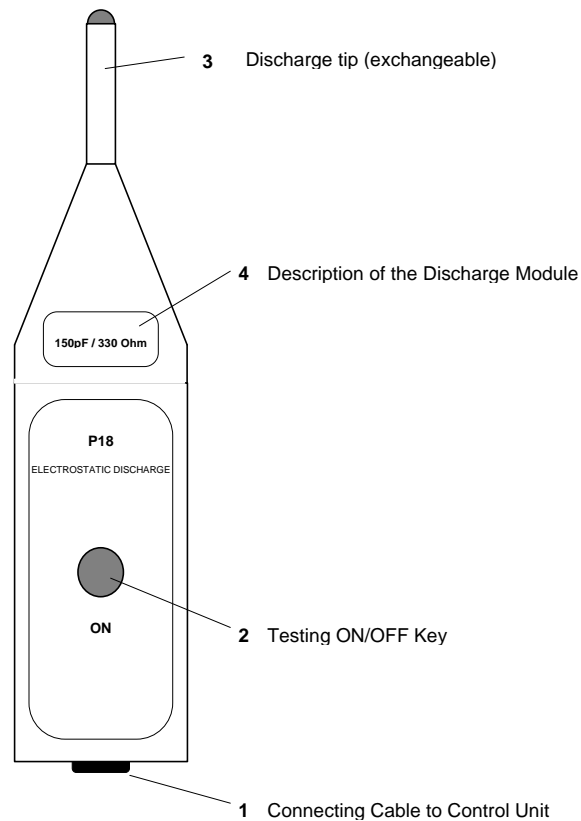

##### 1 Connecting Cable to Control Unit

The connecting cable supplies and controls the discharge unit. There is a plug on each side of the cable so that the connection between control unit and discharge unit is flexible.

*Advantage:* fast exchange of the discharge modules.

##### 2 Testing On / Off Key

After all pre-adjustments of the control unit have been conducted, testing is released by pressing ON/OFF key. For continuous respectively statistical testing consult the previous section.

##### 3 Exchangeable discharge tip

Generally two different discharge tips are available:

- round electrode for air discharge
- sharp electrode for contact discharge

##### 4 Description of Discharge Module

The data of the different discharge units are printed at this place.

*Example:* 150pF / 330 ohm.

##### Polarity Reversal (rear part)

Rearranging the polarity switch (turn 180°) enables to choose between positive and negative test voltage. Opening the switch, high voltage is automatically turned off.

##### Discharge Return Cable (rear part)

The discharge module is connected with the discharge return cable to the earth reference plane.

## 13. Appendix

### 13.1. Declaration of CE-Conformity

Manufacturer : **EM TEST AG**  
 Address: Sternenhofstr. 15CH 4153 Reinach  
 Switzerland

declares, that under is sole responsibility, the product's listed below, including all their options, are conformity with the applicable CE directives listed below using the relevant section of the following EC standards and other normative documents.

Product's name: Ultra compact generator  
 Model Number(s) UCS 500, UCS 500 M4, UCS 500 M6, UCS 500 M6A

#### Low Voltage Directive 73/23/EEC

Standard to which conformity is declared:

EN 61010-1 Safety requirements for electrical equipment for measurement, control, and laboratory use.

#### EMC Directive 89/336/EEC

Standard(s) to which conformity is declared:

EN 61326 Electrical equipment for measurement, control and laboratory use Class A  
 EN 61000-3-2 Limits for harmonic current emissions  
 EN 61000-3-3 Limitation of voltage changes, voltage fluctuations and flicker in public low-voltage supply systems.

European representative  
 EM TEST GmbH  
 Lünenerstr. 211  
 D 59174 Kamen  
 Tel: 00492307-18042  
 Fax: 00492307-17050

Manufacturer  
 EM TEST AG  
 Sternenhofstr. 15  
 CH 4153 Reinach  
 Tel: 004161-7179191  
 Fax: 004161-7179199





By U. Flor  
 General manager  
 Place Kamen, Germany  
 Date 11. November 2002

H. Kunkel  
 Design and Research  
 Reinach BL , Switzerland  
 11. November 2002

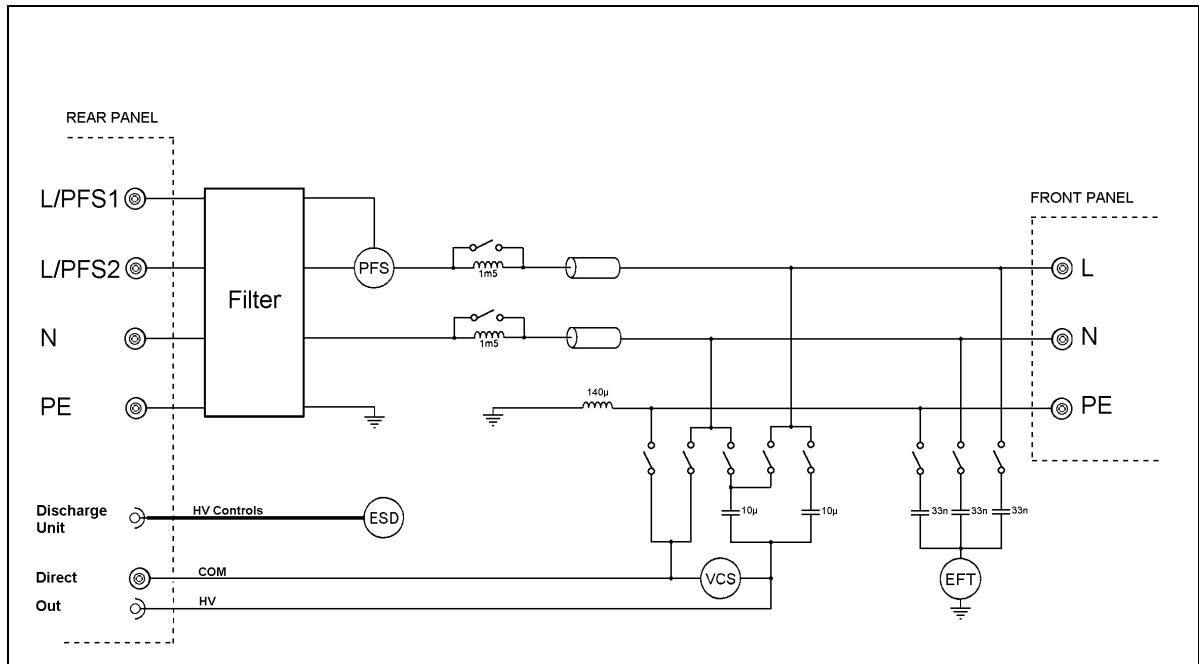
### 13.2. UCS 500 M - General Diagram

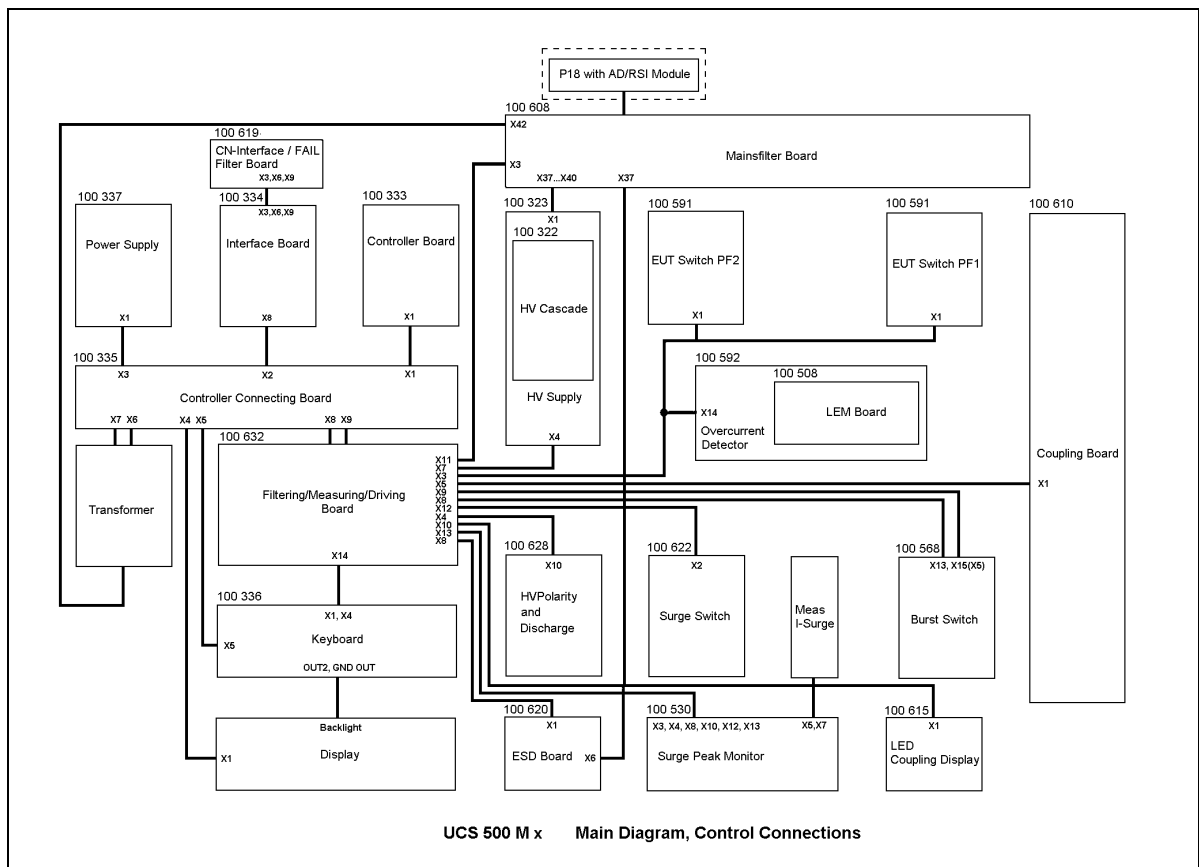

### 13.3. Main diagram control connection



UCS 500 M x Main Diagram, Control Connections



13.4. Main diagram high voltage connection

