

DESCRIPTION

Reed Relays consist of a reed switch and coil fitted into a housing, which could be plastic, metal or moulded. Compared with electromechanical relays, reed relays generally have a faster response time, lower coil consumption and are smaller in size. Furthermore, the switch is sealed in a dry, inert atmosphere preventing the ingress of contaminants.

OPERATION

High Voltage Relays have outstanding performance in insulation and stand-off voltage. Energizing the coil operates a reed switch causing the contacts to open or close. It is important that the switch is not overloaded by applying loads in excess of the switch ratings. For details on switch loads refer to the reed relay specifications and the reed switch application page in this catalogue.

General Parameters

All characteristics for pull-in voltage, drop-out voltage and coil resistance at 20°C ±3°C ambient temperature. For other temperatures see diagram "operating temperature."

Contact Resistance

Initial value at nominal voltage measured by the Kelvin test method at 20V/100mA.

Soldering

During soldering make sure no mechanical stress is applied to terminals because the thermoplastic moulding material might be damaged.

Insulation Resistance

The insulation resistance is measured with a Tera Ohmmeter at 500V DC. The ambient climate is 20°C ±3°C and 50% relative humidity.

Switching Voltage, Switching Current and Power Rating

The listed values for switching voltage, switching current and power rating are absolute limits. If any of these values is exceeded, a reduction of life expectancy will result (see following power diagram).

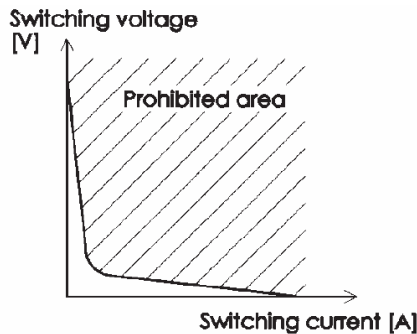

Dielectric Strength

Tested in a radiation (eg. light, x-ray) free environment by applying a DC voltage across the open contacts, between adjacent contacts and between coil and contact. The test current is 100 mA. The unused contacts should not be connected during the test.

Switching Time

Pull-in time including bounce time at nominal voltage and 20 Hz: 1.5 - 3.5 ms
Release time (without diode) at nominal voltage and 20 Hz: 0.4 - 1.5 ms.

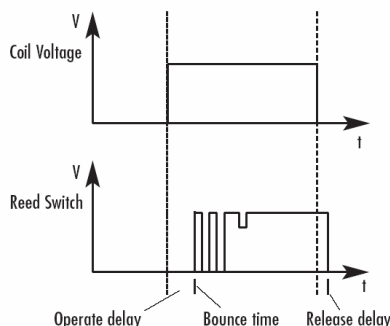

All dimensions are nominal, in millimetres unless otherwise stated.

As part of the groups policy of continued product improvement, specifications may change without notice. Our sales office will be pleased to help you with the latest information on our products.

Contact Capacitance (Typical Values)

Across open contacts	0.8 - 1.2 pF
Between open contact and coil	1.4 - 2.2 pF
Between closed contacts and coil	2.3 - 3.5 pF

Shock and Vibration

During shock and vibration tests the relays must be energized with nominal voltage. The contact should not open or close longer than 10 µs.

Vibration stability: 20 g/50 - 500 Hz. Shock stability: 35 g/11 ms half sine wave.

Life Expectancy

The life expectancy of a Reed Relay is at least 10⁵ - 10⁶ operations at nominal load. At minimum load the life expectancy can endure up to 5 x 10⁸ operations. The mechanical life expectancy is 10⁹ operations (minimum). When switching higher loads, especially inductive or capacitive and lamp loads, life expectancy can be considerably reduced. Proper contact protection will reduce electromagnetic interference and rapid contact erosion.

Operating Temperature

The operating temperature is the internal temperature of the relay (ambient temperature plus self heating). If relays are operating at higher ambient temperatures

(J_u) than +20 °C, the pull-in voltage and the maximum coil voltage must be calculated as follows:

Pull-in voltage = Pull-in voltage at 20 °C x k1.

Maximum coil voltage = Max. coil voltage at 20 °C x k2.

When mounting relays side by side a gap of approximately half the relay-width is recommended to avoid mu-

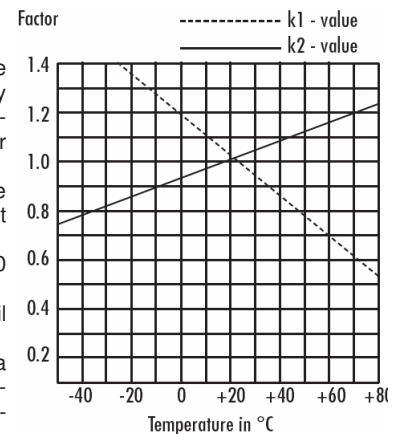

How to order High Voltage Relays:

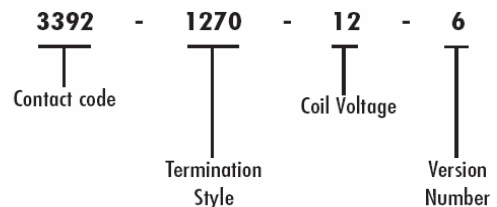

NOTE: All parts of the order code must be completed



			6				6				6			
			1 Normally Open				1 Normally Open				1 Normally Open			
Version Number			3316	3390	3391	3392	3316	3390	3391	3392	3316	3390	3391	3392
Contact Form			1270	1270	1270	1270	1280	1280	1280	1280	1290	1290	1290	1290
Contact Code														
Termination Style														
Contact Parameters														
Switching Voltage	max.	VAC _{peak} /VDC	1500	5000	7500	10000	1500	5000	7500	10000	1500	5000	7500	10000
Dielectric Strength	min.	VDC	3000	7000	10000	14000	3000	7000	10000	14000	3000	7000	10000	14000
Switching Capacity	max.	W	30	50	50	50	30	50	50	50	30	50	50	50
Switching Current	max.	A	1	3	3	3	1	3	3	3	1	3	3	3
Carrying Current	max.	A	2	5	5	5	2	5	5	5	2	5	5	5
Contact Resistance	max.	mΩ	80	250	250	250	80	250	250	250	80	250	250	250
Coil Parameters														
Nominal Coil Voltage		VDC	5	12	24		5	12	24		5	12	24	
Pull-in Voltage	max.	VDC	4	10	20		4	10	20		4	10	20	
Drop-out Voltage	min.	VDC	1	2	4		1	2	4		1	2	4	
Operating Voltage	max.	VDC	8	18	36		8	18	36		8	18	36	
Coil Resistance	±15%	Ω	35	200	720		35	200	720		35	200	720	
Relay Parameters														
Dielectric Strength	coil/contact	VDC	20000				20000				20000			
Dielectric Strength	contact/contact	VDC	-				-				-			
Insulation Resistance	coil/contact	Ω	1 X 10 ⁹				1 X 10 ⁹				1 X 10 ⁹			
Storage Temperature		°C	-35 +90				-35 +90				-35 +90			
Operating Temperature		°C	-20 +70				-20 +70				-20 +70			
Pull-in Time incl. Bounce Time max.		ms	3.5				3.5				3.5			
Drop-out Time		ms	1.5				1.5				1.5			
Weight, approx.		g	55				55				55			

Relays with contact code 3390-91-92 have tungsten-plated switch contacts and should be used only for switching power above approx. 10 mW

TERMINATION STYLES

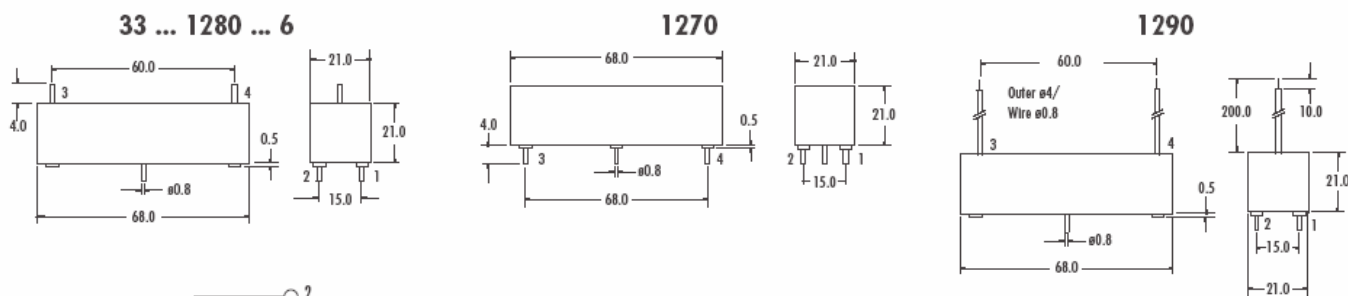

Pin layout

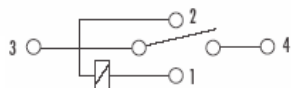

High Voltage - Reed Relays

NORMALLY Open TYPE 33xx . 12xx . xx6

Version Number			6				6				6			
Contact Form			2 Normally Open				4 Normally Open				4 Normally Open			
Contact Code			3316	3390	3391	3392	3316	3390	3391	3392	3316	3390	3391	3392
Termination Style			1272	1272	1272	1272	1274	1274	1274	1274	1294	1294	1294	1294
Contact Parameters														
Switching Voltage	max.	VAC _{peak} /VDC	1500	5000	7500	10000	1500	5000	7500	10000	1500	5000	7500	10000
Dielectric Strength	min.	VDC	3000	7000	10000	14000	3000	7000	10000	14000	3000	7000	10000	14000
Switching Capacity	max.	W	30	50	50	50	30	50	50	50	30	50	50	50
Switching Current	max.	A	1	3	3	3	1	3	3	3	1	3	3	3
Carrying Current	max.	A	2	5	5	5	2	5	5	5	2	5	5	5
Contact Resistance	max.	mΩ	80	250	250	250	80	250	250	250	80	250	250	250
Coil Parameters														
Nominal Coil Voltage		VDC	5	12	24		5	12	24		5	12	24	
Pull-in Voltage	max.	VDC	4	10	20		4	10	20		4	10	20	
Drop-out Voltage	min.	VDC	0.5	1.2	2.4		0.5	1	2		0.5	1	2	
Operating Voltage	max.	VDC	7	16	29		7	14.5	27		7	14.5	27	
Coil Resistance	±15%	Ω	15	85	275		12	42	175		12	42	175	
Relay Parameters														
Dielectric Strength	coil/contact	VDC	10000				10000				10000			
Dielectric Strength	contact/contact	VDC	10000				8000				8000			
Insulation Resistance	coil/contact	Ω	1 X 10 ⁹				1 X 10 ⁹				1 X 10 ⁹			
Storage Temperature		°C	-35 +90				-35 +90				-35 +90			
Operating Temperature		°C	-20 +70				-20 +70				-20 +70			
Pull-in Time incl. Bounce Time	max.	ms	3.5				3.5				3.5			
Drop-out Time		ms	1.5				1.5				1.5			
Weight, approx.		g	55				130				130			

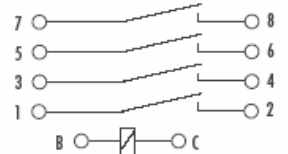
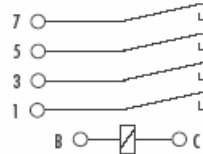
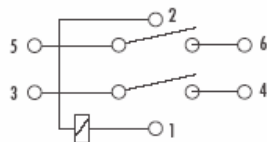

Relays with contact code 3390-91-92 have tungsten-plated switch contacts and should be used only for switching power above approx. 10 mW

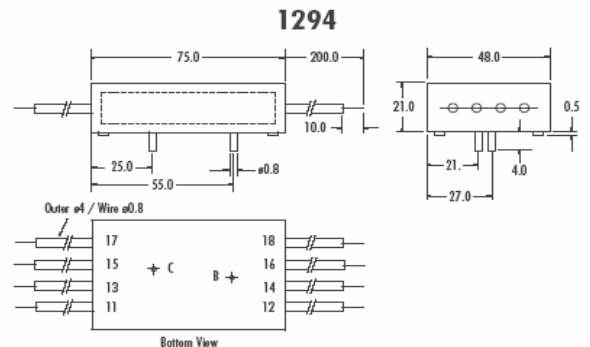
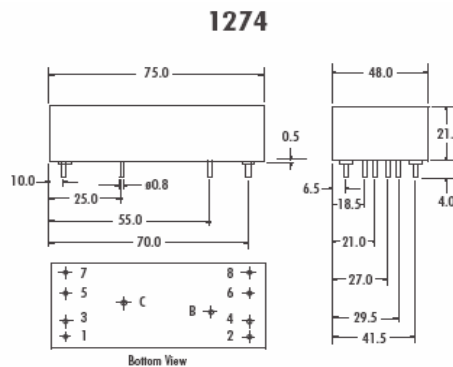
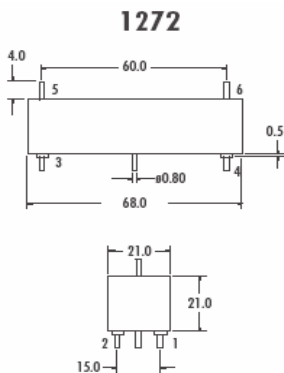

High Voltage - Reed Relays

NORMALLY CLOSED TYPE 33xx . 42xx . xx6

Version Number			6				6				6			
Contact Form			1 Normally Closed				1 Normally Closed				1 Normally Closed			
Contact Code			3316	3390	3391	3392	3316	3390	3391	3392	3316	3390	3391	3392
Termination Style			4270	4270	4270	4270	4280	4280	4280	4280	4290	4290	4290	4290
Contact Parameters														
Switching Voltage	max.	VAC _{peak} /VDC	1500	5000	7500	10000	1500	5000	7500	10000	1500	5000	7500	10000
Dielectric Strength	min.	VDC	3000	7000	10000	14000	3000	7000	10000	14000	3000	7000	10000	14000
Switching Capacity	max.	W	30	50	50	50	30	50	50	50	30	50	50	50
Switching Current	max.	A	1	3	3	3	1	3	3	3	1	3	3	3
Carrying Current	max.	A	2	5	5	5	2	5	5	5	2	5	5	5
Contact Resistance	max.	mΩ	80	250	250	250	80	250	250	250	80	250	250	250
Coil Parameters														
Nominal Coil Voltage		VDC	5	12	24		5	12	24		5	12	24	
Pull-in Voltage	max.	VDC	4	10	20		4	10	20		4	10	20	
Drop-out Voltage	min.	VDC	0.5	1	2		0.5	1	2		0.5	1	2	
Operating Voltage	max.	VDC	6.5	14.5	27		6.5	14.5	27		6.5	14.5	27	
Coil Resistance	±15%	Ω	50	400	675		50	400	675		50	400	675	
Relay Parameters														
Dielectric Strength	coil/contact	VDC	20000				20000				20000			
Dielectric Strength	contact/contact	VDC	-				-				-			
Insulation Resistance	coil/contact	Ω	1 X 10 ⁹				1 X 10 ⁹				1 X 10 ⁹			
Storage Temperature		°C	-35 +90				-35 +90				-35 +90			
Operating Temperature		°C	-20 +70				-20 +70				-20 +70			
Pull-in Time incl. Bounce Time max.		ms	3.5				3.5				3.5			
Drop-out Time		ms	1.5				1.5				1.5			
Weight, approx.		g	55				55				55			

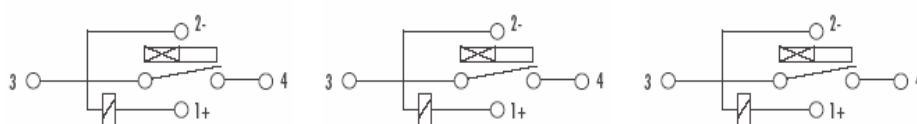

Relays with contact code 3390-91-92 have tungsten-plated switch contacts and should be used only for switching power above approx. 10 mW

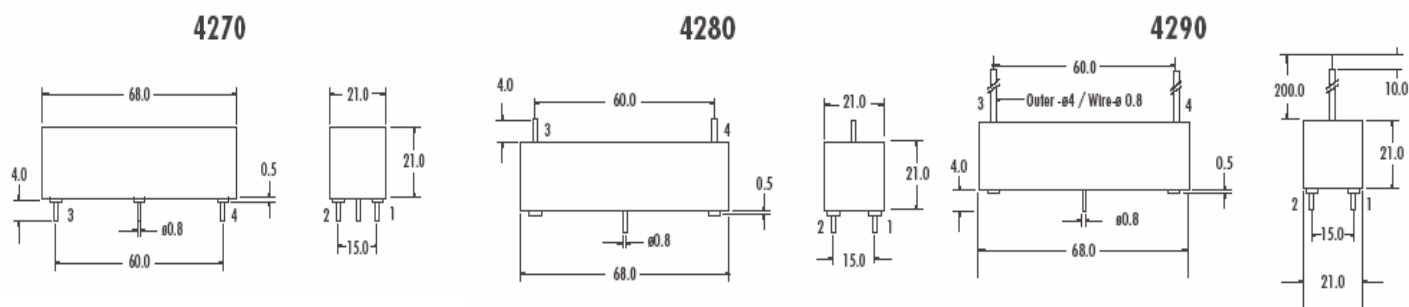

High Voltage - Reed Relays

NORMALLY CLOSED TYPE 33xx . 52xx . xx6

Version Number			6				6			
Contact Form			1 NO + 1NC				1 NO + 1NC			
Contact Code			3316	3390	3391	3392	3316	3390	3391	3392
Termination Style			5272	5272	5272	5272	5292	5292	5292	5692
Contact Parameters										
Switching Voltage	max.	VACpeak/VDC	1500	5000	7500	10000	1500	5000	7500	10000
Dielectric Strength	min.	VDC	3000	7000	10000	14000	3000	7000	10000	14000
Switching Capacity	max.	W	30	50	50	50	30	50	50	50
Switching Current	max.	A	1	3	3	3	1	3	3	3
Carrying Current	max.	A	2	5	5	5	2	5	5	5
Contact Resistance	max.	mΩ	80	250	250	250	80	250	250	250
Coil Parameters										
Nominal Coil Voltage		VDC	5	12	24		5	12	24	
Pull-in Voltage	max.	VDC	4	10	20		4	10	20	
Drop-out Voltage	min.	VDC	0.5	1	2		0.5	1	2	
Operating Voltage	max.	VDC	7.5	14.5	27		7.5	14.5	27	
Coil Resistance	±15%	Ω	27	135	345		27	135	345	
Relay Parameters										
Dielectric Strength	coil/contact	VDC	10000				10000			
Dielectric Strength	contact/contact	VDC	8000				8000			
Insulation Resistance	coil/contact	Ω	1 X 10 ⁹				1 X 10 ⁹			
Storage Temperature		°C	-35 +90				-35 +90			
Operating Temperature		°C	-20 +70				-20 +70			
Pull-in Time incl. Bounce Time max.		ms	3.5				3.5			
Drop-out Time		ms	1.5				1.5			
Weight, approx.		g	130				130			

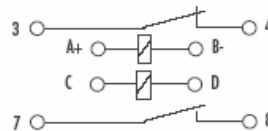
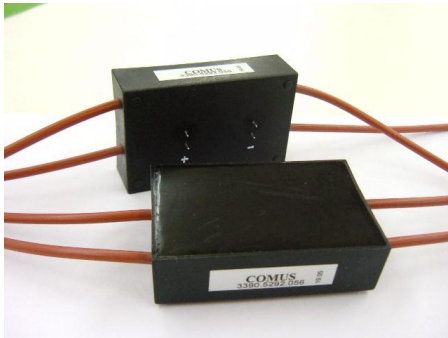

Relays with contact code 3390-91-92 have tungsten-plated switch contacts and should be used only for switching power above approx. 10 mW

TERMINATION STYLES

5272

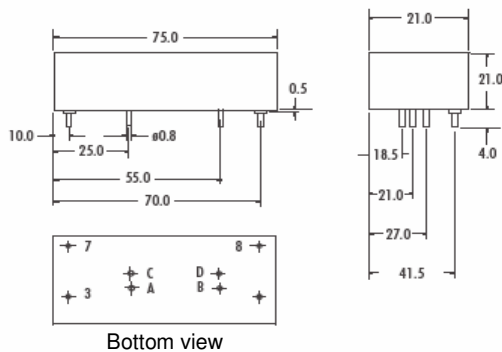

5292

